

VEVOR[®]

TOUGH TOOLS, HALF PRICE

Technical Support and E-Warranty Certificate

www.vevor.com/support

RECORD PLAYER STAND RACK

USER MANUAL

MODEL NO.: C240354G-01

We continue to be committed to provide you tools with competitive price. "Save Half", "Half Price" or any other similar expressions used by us only represents an estimate of savings you might benefit from buying certain tools with us compared to the major top brands and does not necessarily mean to cover all categories of tools offered by us. You are kindly reminded to verify carefully when you are placing an order with us if you are actually Saving Half in comparison with the top major brands.

VEVOR®

TOUGH TOOLS, HALF PRICE

Record Player Stand Rack

MODEL NO.: C240354G-01

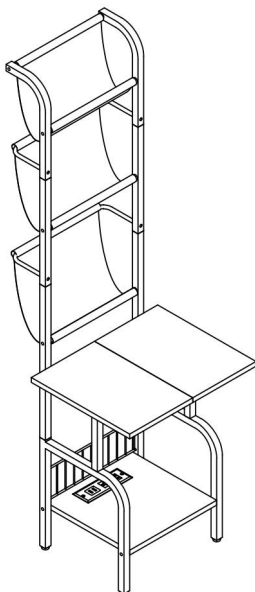

NEED HELP? CONTACT US!

Have product questions? Need technical support? Please feel free to contact us:

Technical Support and E-Warranty Certificate
www.vevor.com/support

This is the original instruction, please read all manual instructions carefully before operating. VEVOR reserves a clear interpretation of our user manual. The appearance of the product shall be subject to the product you received. Please forgive us that we won't inform you again if there are any technology or software updates on our product.

 **WARNING:**

Please read this manual carefully before using the product. Failure to do so may result in serious injury.

ASSEMBLY PRECAUTIONS

1. Assemble only according to these instructions. Improper assembly can create hazards.
2. Wear ANSI-approved safety goggles and heavy-duty work gloves during assembly.
3. Keep the assembly area clean and well-lit.
4. Keep bystanders out of the area during assembly.
5. Do not assemble when tired or when under the influence of alcohol, drugs or medication.
6. The product capabilities apply to properly and completely assembled products only.
7. Assemble on a flat, level, hard and smooth surface capable of safely supporting the Record Player Stand Rack.
8. For additional information regarding the parts listed in the following pages, please refer to the Assembly Diagram of this manual. Unwrap and separate all parts in a clean work area.

SAVE THESE INSTRUCTIONS

USE PRECAUTIONS

TO PREVENT SERIOUS INJURY AND DEATH FROM TIPPING:

1. This product is not a toy. Do not allow children to play with or near this item.
2. Do not exceed weight capacities before moving.
3. Use only on a flat, hard and smooth surface capable of safely supporting a fully loaded Record Player Stand Rack.
4. Use as intended only.
5. Inspect before every use; do not use if parts are loose or damaged.

TECHNICAL SPECIFICATIONS

Model	C240354G-01
Rating(s)	12A, 125Vac, 60Hz, 1500W
Product Dimensions (LxWxH)(mm)	450*490*1430
Net Weight(kg)	About 12.35

*Products such as specifications, appearance, and design are subject to modification without prior notice.

PACKAGE CONTENTS

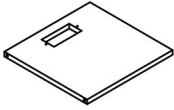

1 1pc

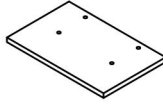

2 2pcs

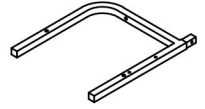

3 1pc

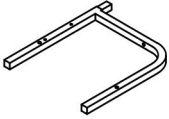

4 1pc

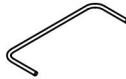

5 2pcs



6 1pc



7 2pcs



8 2pcs



9 2pcs



10 2pcs



11 2pcs

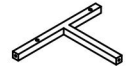







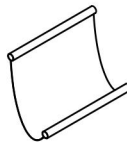









12 2pcs



13 4pcs



14 3pcs

 M7x50MM  4pcs	 M6x30MM  8pcs	 M6x40MM  20pcs	 M3.5x14MM  2pcs	 M6x10MM  2pcs	  1pc	  4pcs
  2pcs						

ASSEMBLY STEPS

1

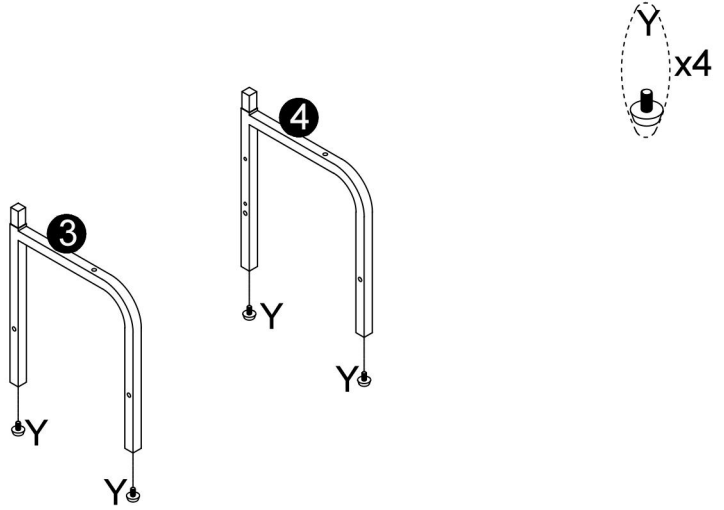

2

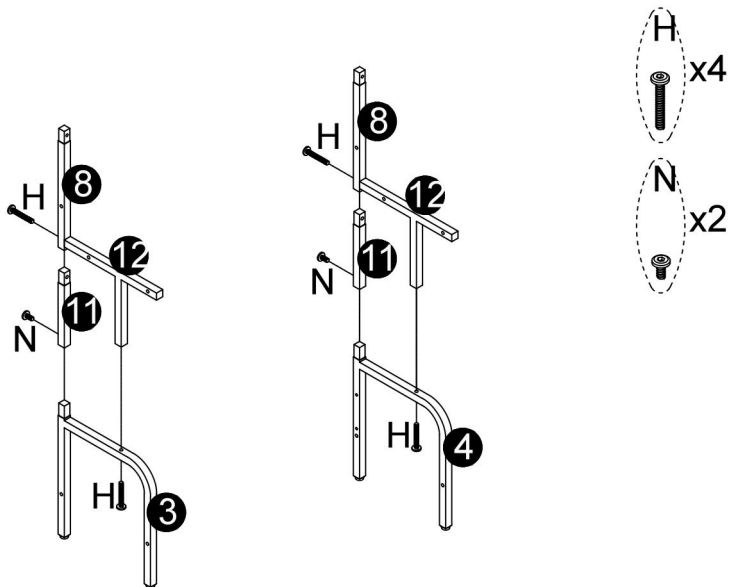

3

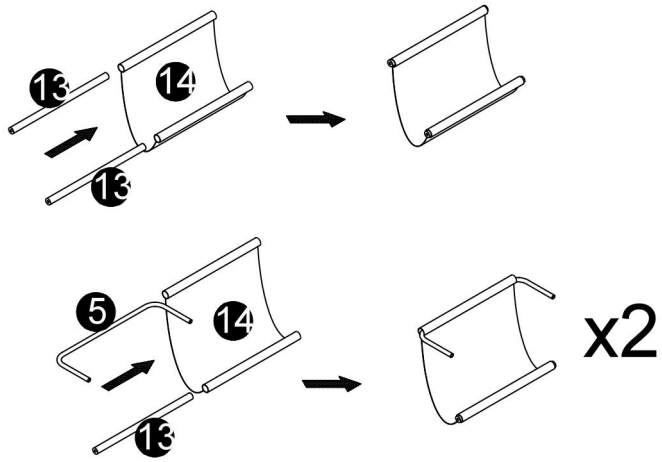

4

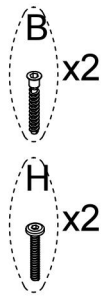
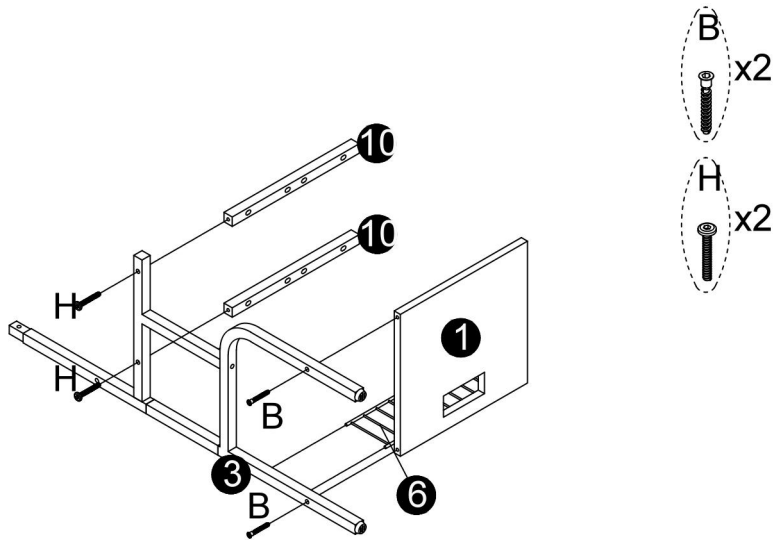

5

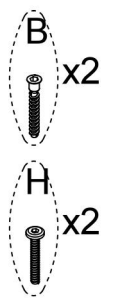
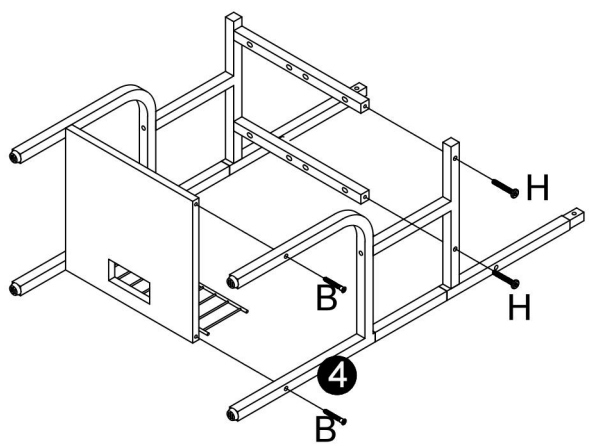

6

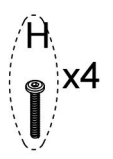
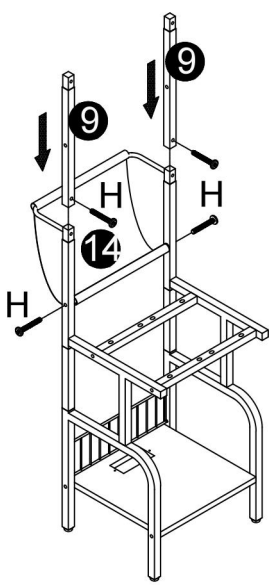

7

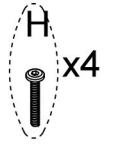
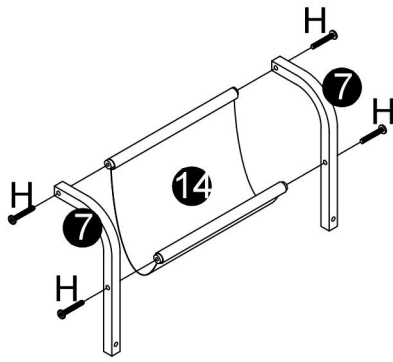

8

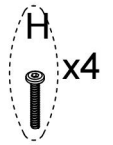
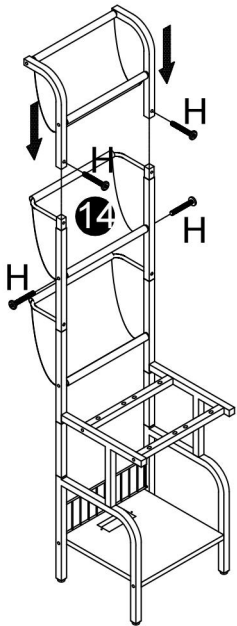

9

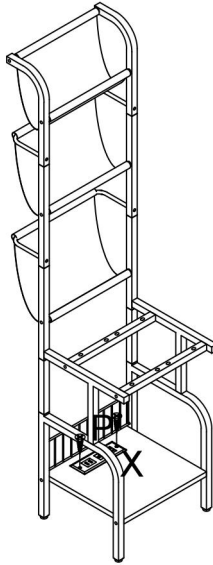

10

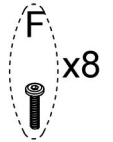
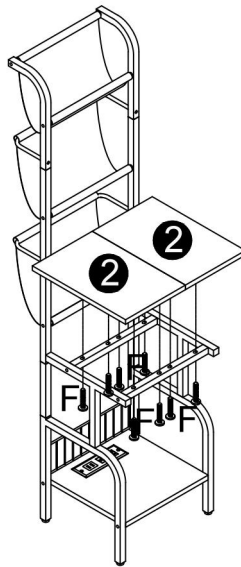

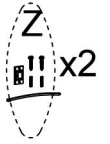

 Attention: For safety and stability, we suggest you have to secure the anti-tip accessories to the wall to prevent tipping, injury, and property damage.

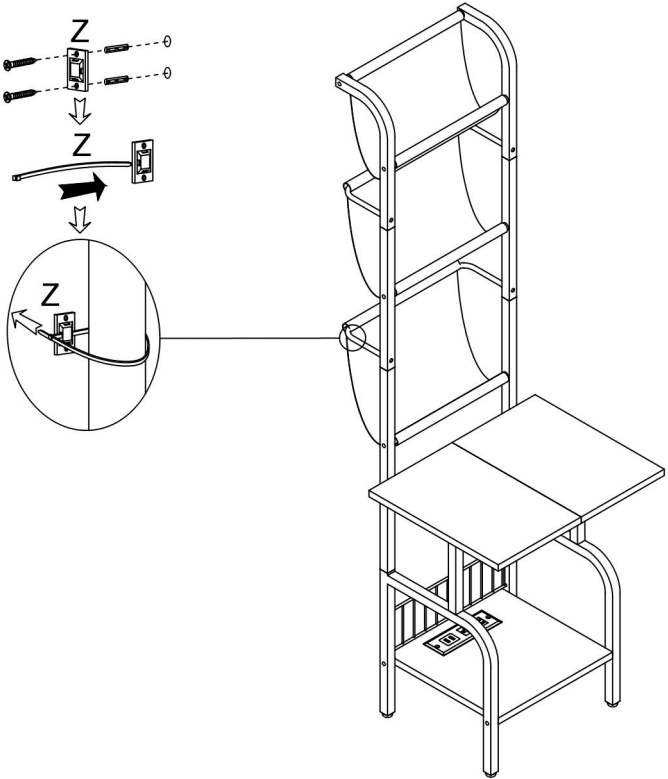

COMPLETION

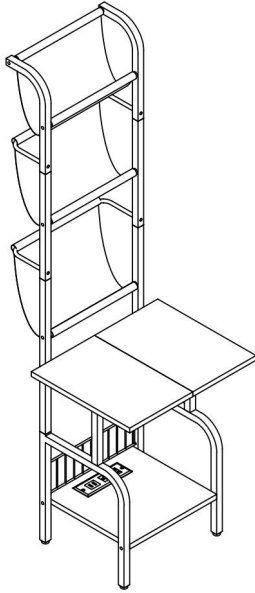

Manufacturer: Shanghaimuxinmuyeyouxiangongsi

Address: Shuangchenglu 803nong11hao1602A-1609shi, baoshanqu, shanghai 200000 CN.

Imported to AUS: SIHAO PTY LTD. 1 ROKEVA STREETEASTWOOD NSW 2122 Australia

Imported to USA: Sanven Technology Ltd. Suite 250, 9166 Anaheim Place, Rancho Cucamonga, CA 91730

UK	REP
-----------	------------

YH CONSULTING LIMITED. C/O YH Consulting Limited Office 147, Centurion House, London Road, Staines-upon-Thames, Surrey, TW18 4AX

EC	REP
-----------	------------

E-CrossStu GmbH
Mainzer Landstr.69,
60329 Frankfurt am Main.

VEVOR[®]

TOUGH TOOLS, HALF PRICE

Technical Support and E-Warranty Certificate

www.vevor.com/support

VEVOR[®]

TOUGH TOOLS, HALF PRICE

Assistance technique et certificat de garantie

électronique www.vevor.com/support

SUPPORT POUR TOURNE-DISQUE

MANUEL D'UTILISATION

MODÈLE N° : C240354G-01

Nous continuons à nous engager à vous fournir des outils à des prix compétitifs.

« Économisez la moitié », « Moitié prix » ou toute autre expression similaire utilisée par nous ne représente qu'une estimation des économies que vous pourriez réaliser en achetant certains outils chez nous par rapport aux grandes marques et ne couvre pas nécessairement toutes les catégories d'outils que nous proposons. Nous vous rappelons de bien vouloir vérifier soigneusement lorsque vous passez une commande chez nous si vous économisez réellement la moitié par rapport aux grandes marques.

VEVOR[®]

TOUGH TOOLS, HALF PRICE

Support pour tourne-disque

MODÈLE N° : C240354G-01

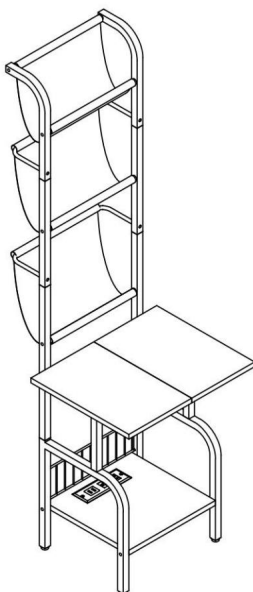

BESOIN D'AIDE? CONTACTEZ-NOUS!

Vous avez des questions sur les produits ? Vous avez besoin d'une assistance technique ? N'hésitez pas à nous contacter :

Assistance technique et certificat de garantie électronique
www.vevor.com/support

Il s'agit de la notice d'utilisation d'origine. Veuillez lire attentivement toutes les instructions du manuel avant de l'utiliser. VEVOR se réserve le droit d'interpréter clairement notre manuel d'utilisation. L'apparence du produit dépend du produit que vous avez reçu. Veuillez nous excuser, nous ne vous informerons plus en cas de mise à jour technologique ou logicielle de notre produit.



AVERTISSEMENT:

Veillez lire attentivement ce manuel avant d'utiliser le produit. Le non-respect de ces instructions
cela pourrait entraîner des blessures graves.

PRÉCAUTIONS D'ASSEMBLAGE

1. Assemblez uniquement selon ces instructions. Un assemblage incorrect peut
créer des dangers.
2. Portez des lunettes de sécurité homologuées ANSI et des gants de travail robustes
pendant le montage.
3. Gardez la zone de montage propre et bien éclairée.
4. Gardez les spectateurs hors de la zone pendant le montage.
5. Ne montez pas lorsque vous êtes fatigué ou sous l'influence de l'alcool, de drogues ou de médicaments.
6. Les capacités du produit s'appliquent aux produits correctement et complètement assemblés.
produits uniquement.
7. Assemblez sur une surface plane, de niveau, dure et lisse capable de supporter en toute sécurité
support du support de tourne-disque.
8. Pour plus d'informations sur les pièces répertoriées ci-dessous
pages, veuillez vous référer au schéma d'assemblage de ce manuel. Déballez et
séparer toutes les pièces dans une zone de travail propre.

CONSERVEZ CES INSTRUCTIONS

PRÉCAUTIONS D'EMPLOI

POUR ÉVITER LES BLESSURES GRAVES ET LA MORT RÉSULTANT DU BASCULEMENT :

1. Ce produit n'est pas un jouet. Ne laissez pas les enfants jouer avec ou à proximité de ce produit. article.
2. Ne pas dépasser les capacités de poids avant de déménager.
3. Utiliser uniquement sur une surface plane, dure et lisse capable de supporter en toute sécurité supportant un support de tourne-disque entièrement chargé.
4. Utiliser uniquement comme prévu.
5. Inspectez avant chaque utilisation ; ne pas utiliser si des pièces sont desserrées ou endommagées.

CARACTÉRISTIQUES TECHNIQUES

Modèle	C240354G-01
Note(s)	12A, 125Vac, 60Hz, 1500W
Dimensions du produit (L x l x H) (mm)	450*490*1430
Poids net (kg)	Environ 12h35

*Les produits tels que les spécifications, l'apparence et la conception sont sous réserve de modification sans préavis.

CONTENU DU COLIS

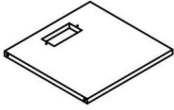

1 1pc

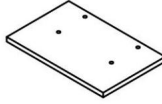

2 2pcs

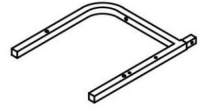

3 1pc

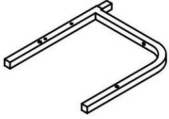

4 1pc

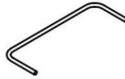

5 2pcs



6 1pc



7 2pcs



8 2pcs



9 2pcs



10 2pcs



11 2pcs

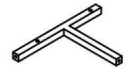







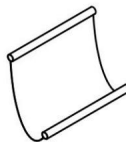









12 2pcs



13 4pcs



14 3pcs

 <p>M7X50MM</p>  <p>4pcs</p>	 <p>M6X30MM</p>  <p>8pcs</p>	 <p>M6X40MM</p>  <p>20pcs</p>	 <p>M3.5X14MM</p>  <p>2pcs</p>	 <p>M6X10MM</p>  <p>2pcs</p>	  <p>1pc</p>	  <p>4pcs</p>
  <p>2pcs</p>						

ÉTAPES D'ASSEMBLAGE

1

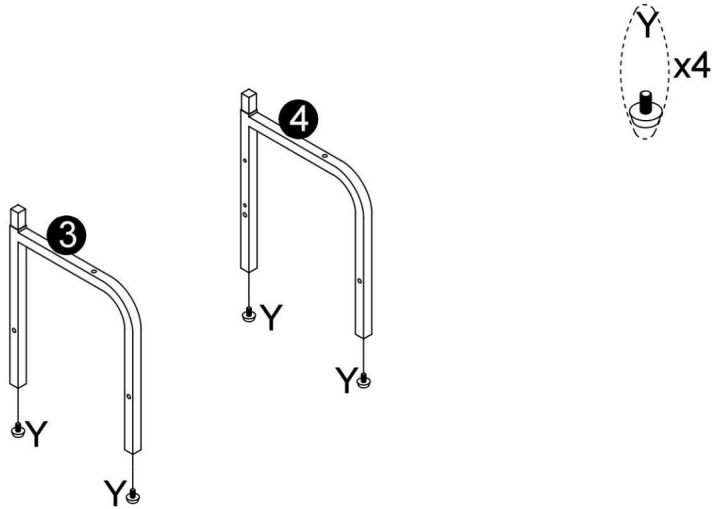

2

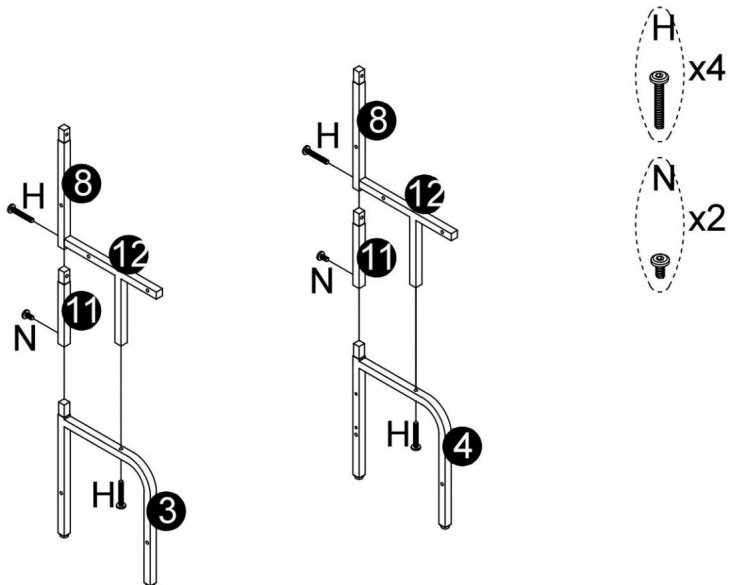

3

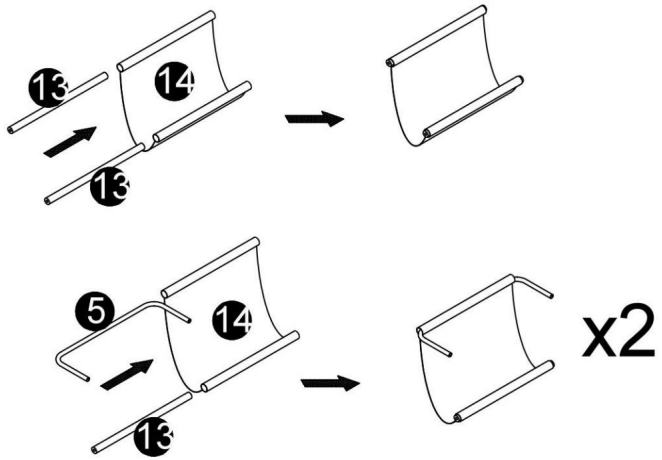

4

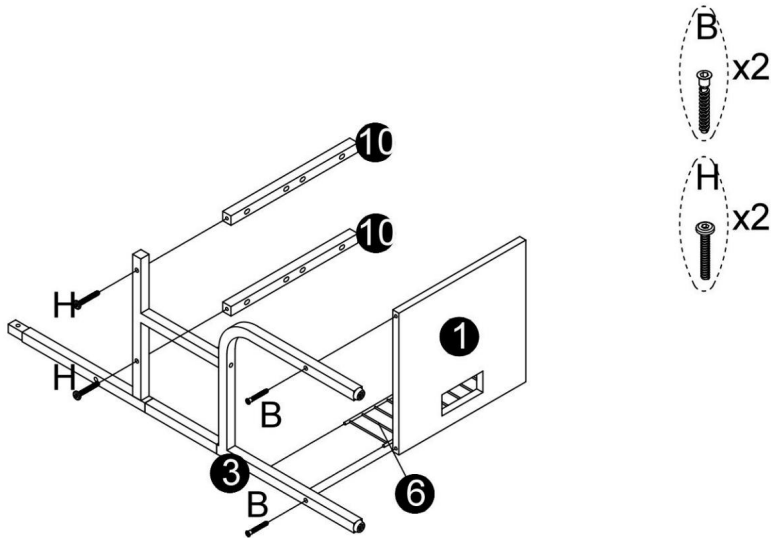

5

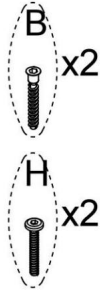
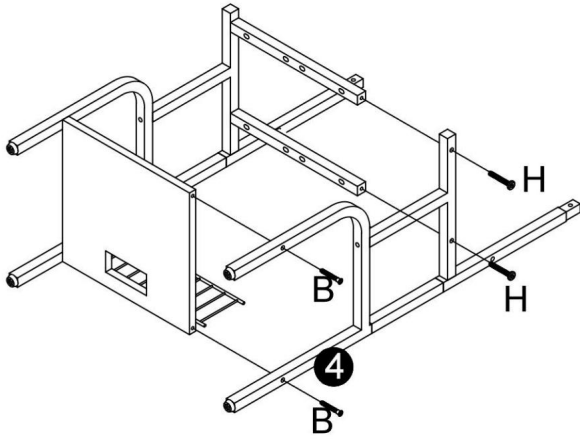

6

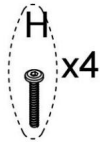
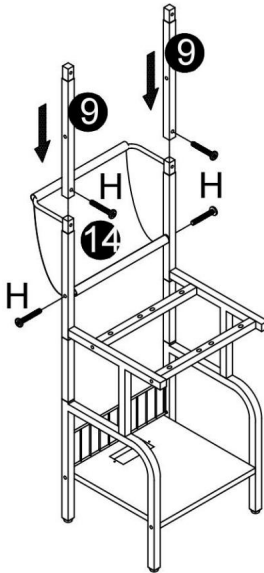

7

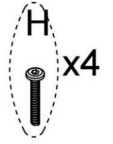
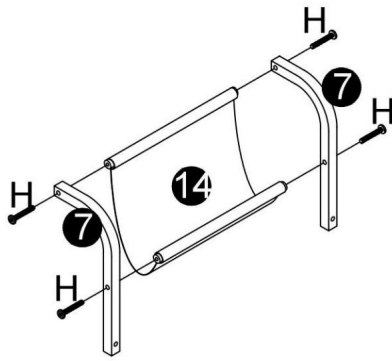

8

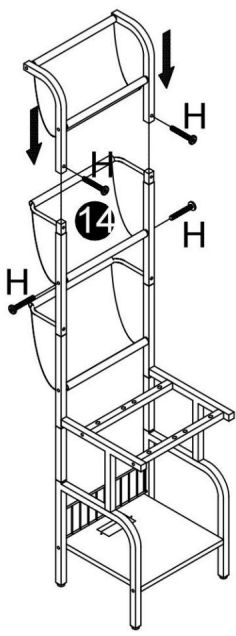

9

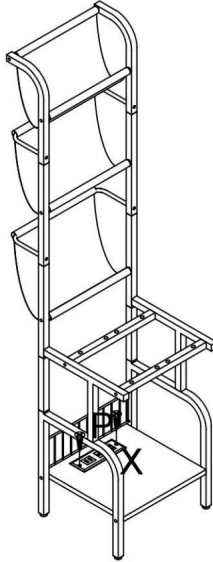

10

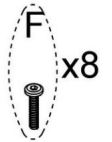
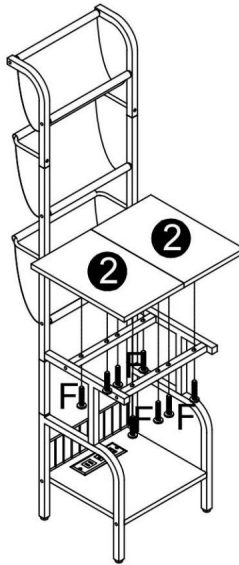

11

Z
x2



Attention: For safety and stability, we suggest you have to secure the anti-tip accessories to the wall to prevent tipping, injury, and property damage.

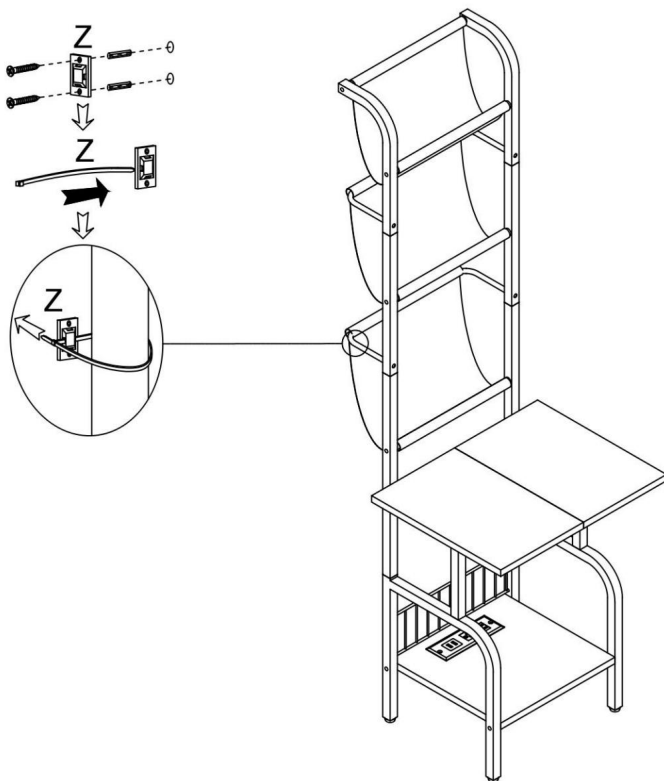

ACHÈVEMENT

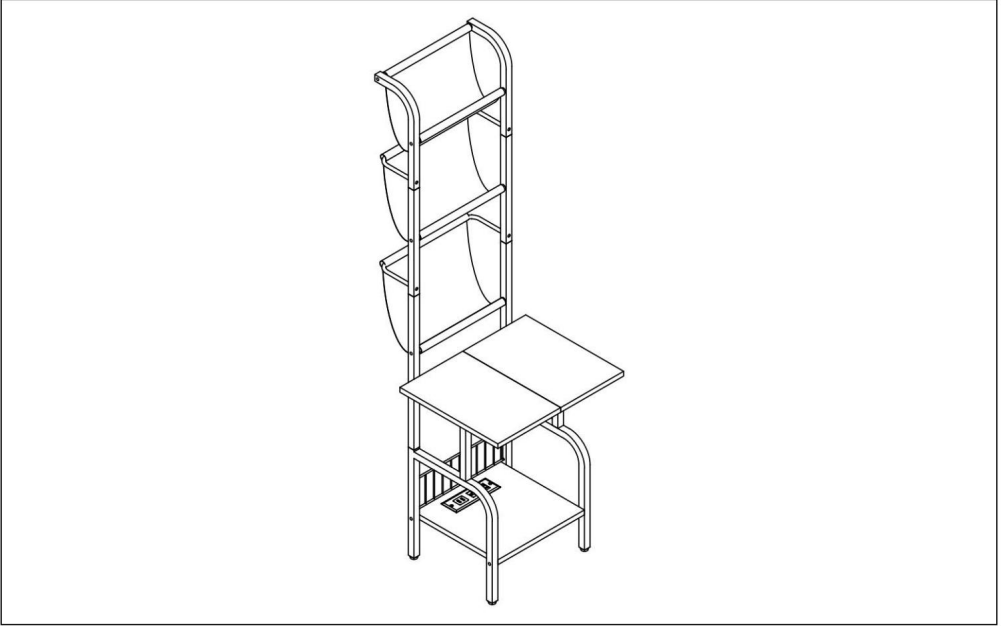

Fabricant : Shanghaimuxinmuyeyouxiangongsi Adresse :
Shuangchenglu 803nong11hao1602A-1609shi, baoshanqu, shanghai 200000 CN.

Importé en Australie : SIHAO PTY LTD. 1 ROKEVA STREETEASTWOOD NSW 2122
Australie

Importé aux États-Unis : Sanven Technology Ltd. Suite 250, 9166 Anaheim Place,
Rancho Cucamonga, CA 91730



YH CONSULTING LIMITED. C/O YH Consulting
Limited Bureau 147, Centurion House, London
Road, Staines-upon-Thames, Surrey, TW18 4AX



E-CrossStu GmbH
Mainzer Landstr.69,
60329 Francfort-sur-le-Main.

VEVOR®

TOUGH TOOLS, HALF PRICE

Assistance technique et certificat de garantie
électronique www.vevor.com/support

VEVOR[®]

TOUGH TOOLS, HALF PRICE

Technischer Support und E-Garantie-Zertifikat
www.vevor.com/support

Plattenspieler-Ständer

BENUTZERHANDBUCH

MODELL-NR.: C240354G-01

Wir sind weiterhin bestrebt, Ihnen Werkzeuge zu wettbewerbsfähigen Preisen anzubieten. „Sparen Sie die Hälfte“, „Halber Preis“ oder andere ähnliche Ausdrücke, die wir verwenden, stellen nur eine Schätzung der Ersparnis dar, die Sie beim Kauf bestimmter Werkzeuge bei uns im Vergleich zu den großen Topmarken erzielen können, und decken nicht unbedingt alle von uns angebotenen Werkzeugkategorien ab. Wir möchten Sie freundlich daran erinnern, bei der Bestellung bei uns sorgfältig zu prüfen, ob Sie im Vergleich zu den großen Topmarken tatsächlich die Hälfte sparen.

VEVOR®

TOUGH TOOLS, HALF PRICE

Plattenspieler-Ständer

MODELL-NR.: C240354G-01

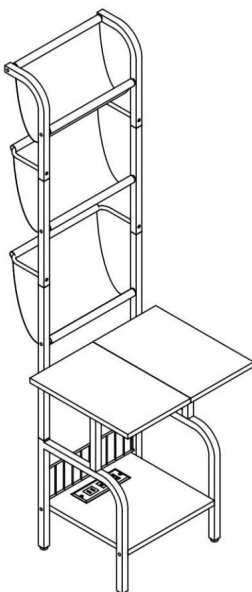

Brauchen Sie Hilfe? Kontaktieren Sie uns!

Sie haben Fragen zu unseren Produkten? Sie benötigen technischen Support? Dann kontaktieren Sie uns gerne:

Technischer Support und E-Garantie-Zertifikat
www.vevor.com/support

Dies ist die Originalanleitung. Bitte lesen Sie alle Anweisungen sorgfältig durch, bevor Sie das Gerät in Betrieb nehmen. VEVOR behält sich eine klare Auslegung unserer Bedienungsanleitung vor. Das Erscheinungsbild des Produkts richtet sich nach dem Produkt, das Sie erhalten haben. Bitte verzeihen Sie uns, dass wir Sie nicht erneut informieren, wenn es Technologie- oder Software-Updates für unser Produkt gibt.



WARNUNG:

**Bitte lesen Sie dieses Handbuch vor der Verwendung des Produkts sorgfältig durch.
Andernfalls kann es zu schweren Verletzungen kommen.**

VORSICHTSMASSNAHMEN BEI DER MONTAGE

1. Die Montage muss gemäß dieser Anleitung erfolgen. Eine unsachgemäße Montage kann Gefahren schaffen.
2. Tragen Sie ANSI-zugelassene Schutzbrillen und strapazierfähige Arbeitshandschuhe bei der Montage.
3. Halten Sie den Versammlungsbereich sauber und gut beleuchtet.
4. Halten Sie während der Montage unbeteiligte Zuschauer vom Bereich fern.
5. Nicht montieren, wenn Sie müde sind oder unter dem Einfluss von Alkohol, Drogen oder Medikamenten stehen.
6. Die Produkteigenschaften gelten für ordnungsgemäß und vollständig montierte Nur Produkte.
7. Auf einer flachen, ebenen, harten und glatten Oberfläche montieren, die sicher zur Unterstützung des Plattenspielerständers.
8. Weitere Informationen zu den im Folgenden aufgeführten Teilen finden Sie
Seiten finden Sie im Montageplan dieses Handbuchs. Auspacken und
Trennen Sie alle Teile in einem sauberen Arbeitsbereich.

BEWAHREN SIE DIESE ANWEISUNGEN AUF

VORSICHTSMASSNAHMEN BEIM GEBRAUCH

UM SCHWERE VERLETZUNGEN UND TOD DURCH KIPPEN ZU VERMEIDEN:

1. Dieses Produkt ist kein Spielzeug. Erlauben Sie Kindern nicht, mit oder in der Nähe dieses Artikel.
2. Überschreiten Sie vor dem Bewegen nicht die zulässige Gewichtsgrenze.
3. Nur auf einer flachen, harten und glatten Oberfläche verwenden, die sicher zur Unterstützung eines voll beladenen Plattenspielerständers.
4. Nur bestimmungsgemäß verwenden.
5. Vor jedem Gebrauch prüfen; nicht verwenden, wenn Teile lose oder beschädigt sind.

TECHNISCHE DATEN

Modell	C240354G-01
Bewertung(en)	12 A, 125 V Wechselstrom, 60 Hz, 1500 W
Technische Daten (L x B x H) (mm)	450*490*1430
Nettogewicht (kg)	Etwa 12.35

*Produkte wie Spezifikationen, Aussehen und Design sind Änderungen ohne vorherige Ankündigung vorbehalten.

PACKUNGSIHALT

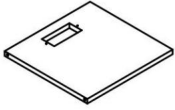

1 1pc

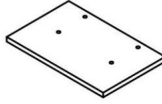

2 2pcs

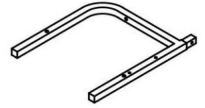

3 1pc

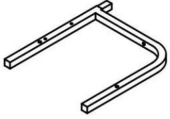

4 1pc



5 2pcs



6 1pc



7 2pcs



8 2pcs



9 2pcs



10 2pcs



11 2pcs

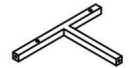







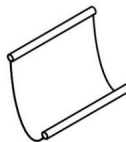









12 2pcs



13 4pcs



14 3pcs

 M7X50MM  4pcs	 M6X30MM  8pcs	 M6X40MM  20pcs	 M3.5X14MM  2pcs	 M6X10MM  2pcs	  1pc	  4pcs
 2pcs						

MONTAGEANLEITUNG

1

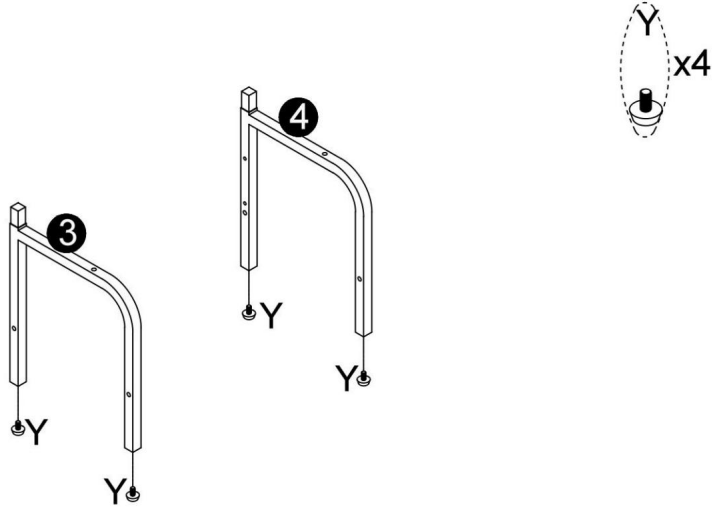

2

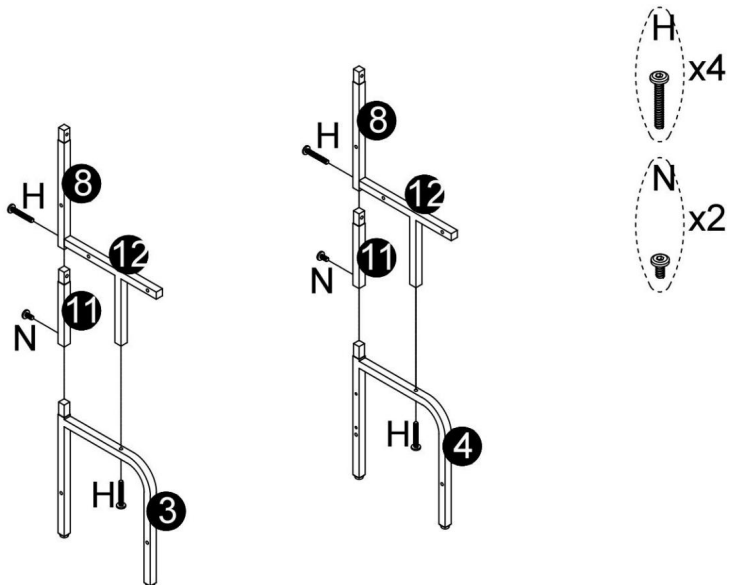

3

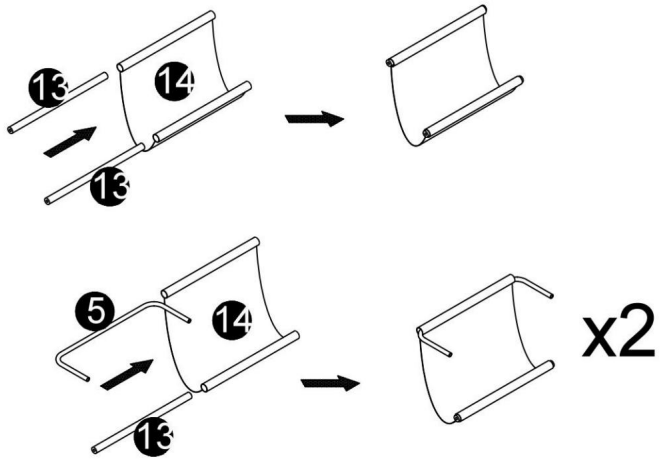

4

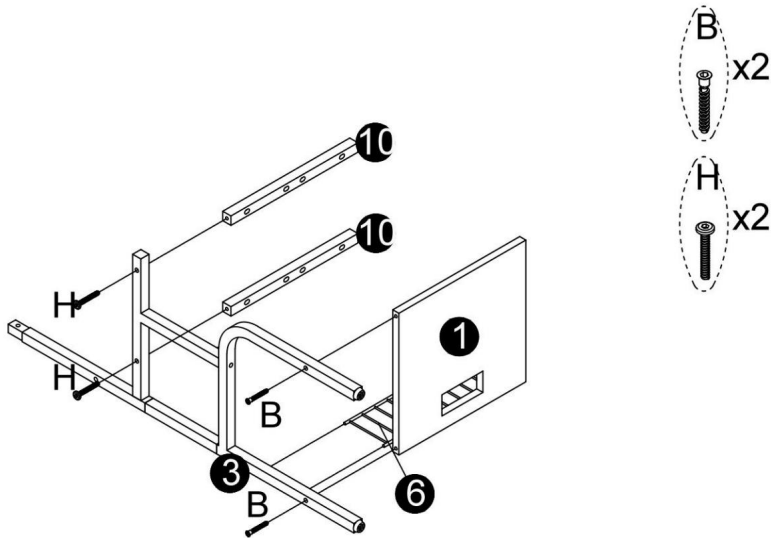

5

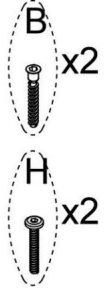
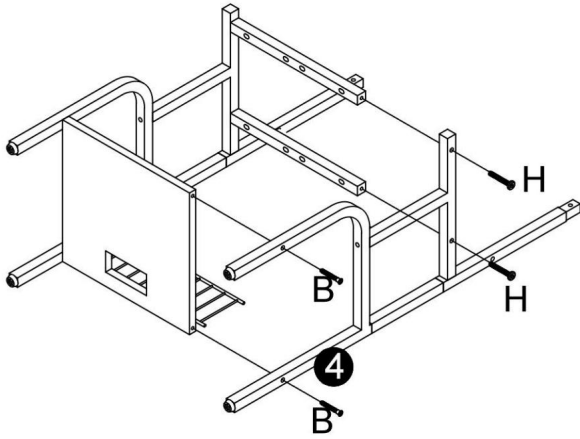

6

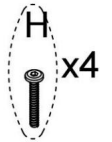
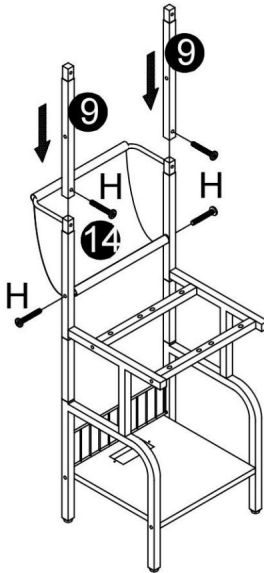

7

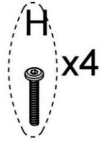
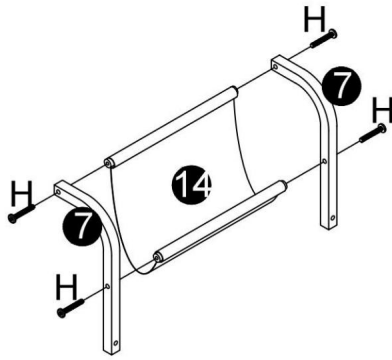

8

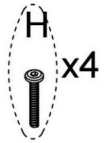
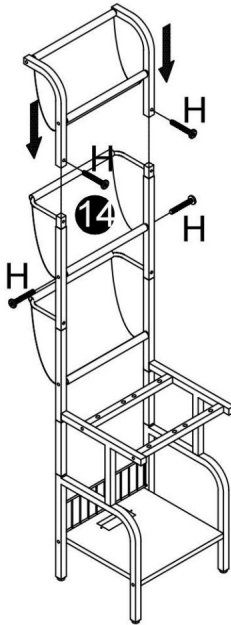

9

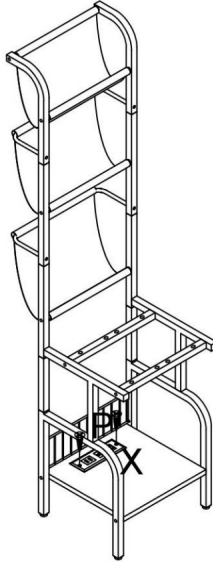

10

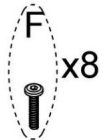
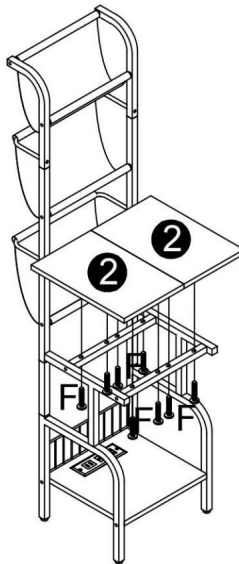

11

Z
x2



Attention: For safety and stability, we suggest you have to secure the anti-tip accessories to the wall to prevent tipping, injury, and property damage.

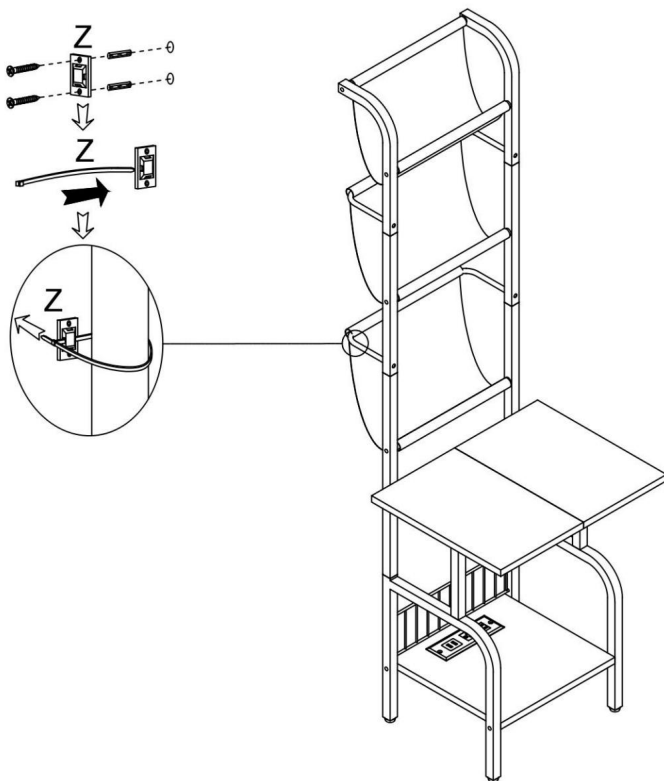

FERTIGSTELLUNG

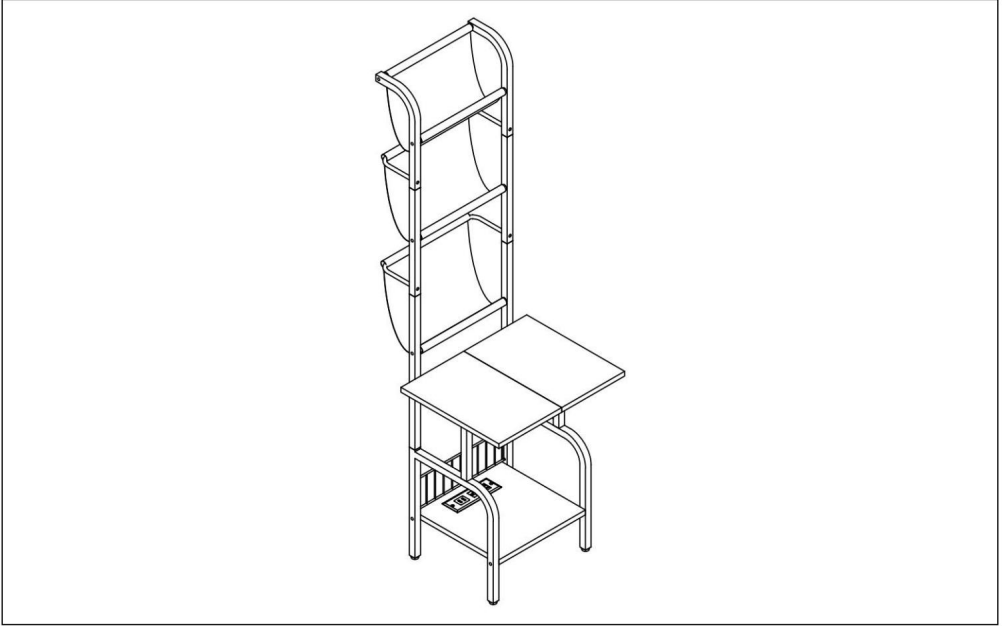

Hersteller: Shanghaimuxinmuyeyouxiangongsi **Adresse:**

Shuangchenglu 803nong11hao1602A-1609shi, baoshanqu, Shanghai 200000 CN.

Nach AUS importiert: SIHAO PTY LTD. 1 ROKEVA STREETEASTWOOD NSW 2122
Australien

Importiert in die USA: Sanven Technology Ltd. Suite 250, 9166 Anaheim Place,
Rancho Cucamonga, CA 91730



YH CONSULTING LIMITED. C/O YH Consulting
Limited Office 147, Centurion House, London
Road, Staines-upon-Thames, Surrey, TW18 4AX

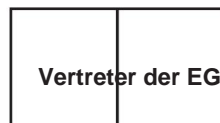

E-CrossStu GmbH
Mainzer Landstr.69,
60329 Frankfurt am Main.

VEVOR[®]

TOUGH TOOLS, HALF PRICE

Technischer Support und E-Garantie-Zertifikat

www.vevor.com/support

VEVOR[®]

TOUGH TOOLS, HALF PRICE

Supporto tecnico e certificato di garanzia elettronica

www.vevor.com/support

SUPPORTO PER GIRADISCHI

MANUALE D'USO

MODELLO NUMERO: C240354G-01

Continuiamo a impegnarci per fornirvi strumenti a prezzi competitivi.

"Risparmia la metà", "Metà prezzo" o qualsiasi altra espressione simile da noi utilizzata rappresenta solo una stima del risparmio che potresti ottenere acquistando determinati utensili con noi rispetto ai principali marchi principali e non significa necessariamente coprire tutte le categorie di utensili da noi offerti. Ti ricordiamo gentilmente di verificare attentamente quando effettui un ordine con noi se stai effettivamente risparmiando la metà rispetto ai principali marchi principali.

VEVOR[®]

TOUGH TOOLS, HALF PRICE

Supporto per giradischi

MODELLO NUMERO: C240354G-01

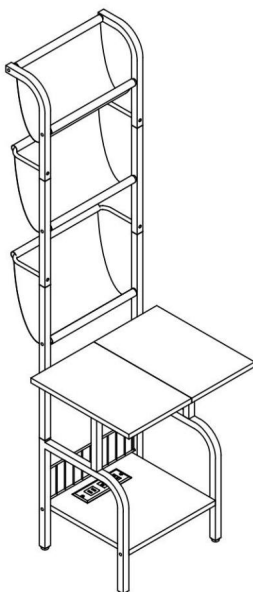

HAI BISOGNO DI AIUTO? CONTATTACI!

Hai domande sui prodotti? Hai bisogno di supporto tecnico? Non esitare a contattarci:

Supporto tecnico e certificato di garanzia elettronica

www.vevor.com/support

Questa è l'istruzione originale, si prega di leggere attentamente tutte le istruzioni del manuale prima di utilizzare. VEVOR si riserva una chiara interpretazione del nostro manuale utente. L'aspetto del prodotto sarà soggetto al prodotto ricevuto. Vi preghiamo di perdonarci se non vi informeremo di nuovo se ci sono aggiornamenti tecnologici o software sul nostro prodotto.



AVVERTIMENTO:

Si prega di leggere attentamente il presente manuale prima di utilizzare il prodotto. La mancata farlo potrebbe causare gravi lesioni.

PRECAUZIONI DI MONTAGGIO

1. Montare solo secondo queste istruzioni. Un montaggio improprio può creare pericoli.
2. Indossare occhiali di sicurezza approvati ANSI e guanti da lavoro resistenti durante l'assemblaggio.
3. Mantenere l'area di assemblaggio pulita e ben illuminata.
4. Tenere gli astanti fuori dall'area durante l'assemblea.
5. Non riunirsi quando si è stanchi o sotto l'effetto di alcol, droghe o farmaci.
6. Le capacità del prodotto si applicano a prodotti correttamente e completamente assemblati solo prodotti.
7. Montare su una superficie piana, livellata, dura e liscia in grado di sostenere in modo sicuro per sostenere il supporto del giradischi.
8. Per ulteriori informazioni sulle parti elencate di seguito pagine, fare riferimento allo schema di montaggio di questo manuale. Scartare e separare tutte le parti in un'area di lavoro pulita.

SALVA QUESTE ISTRUZIONI

PRECAUZIONI D'USO

PER PREVENIRE LESIONI GRAVI E MORTALI DOVUTE AL RIBALTAMENTO:

1. Questo prodotto non è un giocattolo. Non permettere ai bambini di giocare con o vicino a questo articolo.
2. Non superare la capacità di peso prima dello spostamento.
3. Utilizzare solo su una superficie piana, dura e liscia in grado di resistere in modo sicuro per sostenere un supporto per giradischi completamente carico.
4. Utilizzare solo come previsto.
5. Ispezionare prima di ogni utilizzo; non utilizzare se alcune parti sono allentate o danneggiate.

SPECIFICHE TECNICHE

Modello	C240354G-01
Valutazione(i)	12A, 125Vac, 60Hz, 1500W
Dimensioni del prodotto <small>(Lunghezza x Larghezza x Altezza)(mm)</small>	Dimensioni: 450*490*1430
Peso netto (kg)	Circa 12.35

*Prodotti come specifiche, aspetto e design sono
soggetto a modifiche senza preavviso.

CONTENUTO DELLA CONFEZIONE

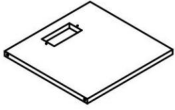

1 1pc

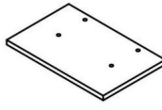

2 2pcs

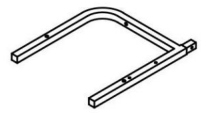

3 1pc

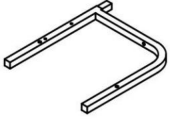

4 1pc



5 2pcs



6 1pc



7 2pcs



8 2pcs



9 2pcs



10 2pcs



11 2pcs

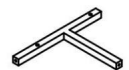







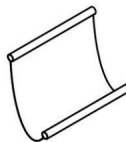









12 2pcs



13 4pcs



14 3pcs

 M7X50MM  4pcs	 M6X30MM  8pcs	 M6X40MM  20pcs	 M3.5X14MM  2pcs	 M6X10MM  2pcs	  1pc	  4pcs
 2pcs						

FASI DI MONTAGGIO

1

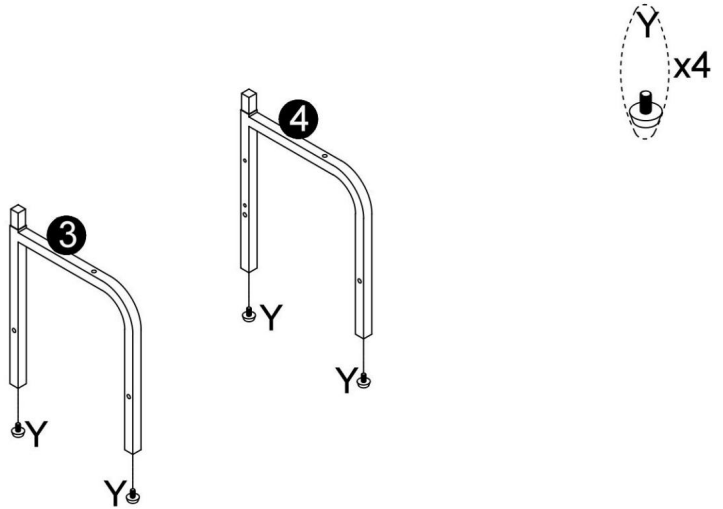

2

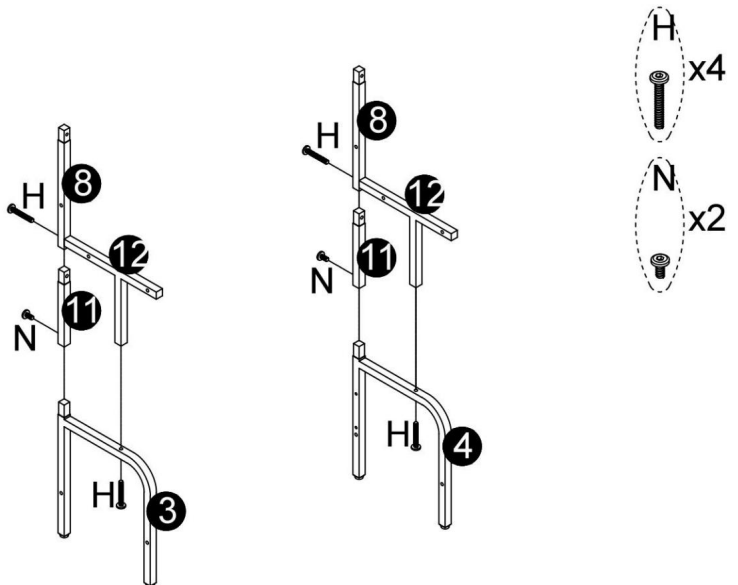

3

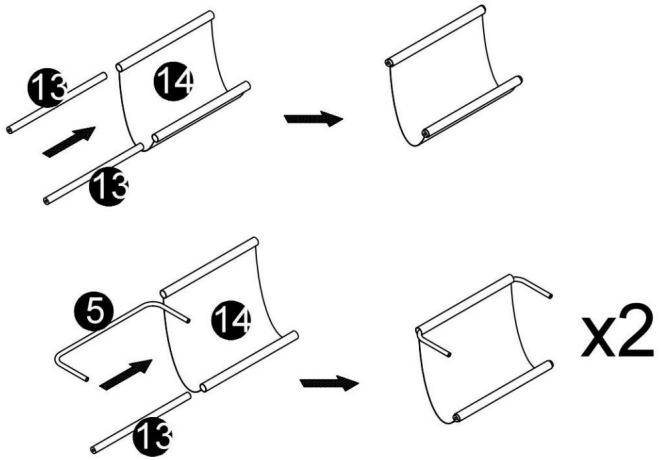

4

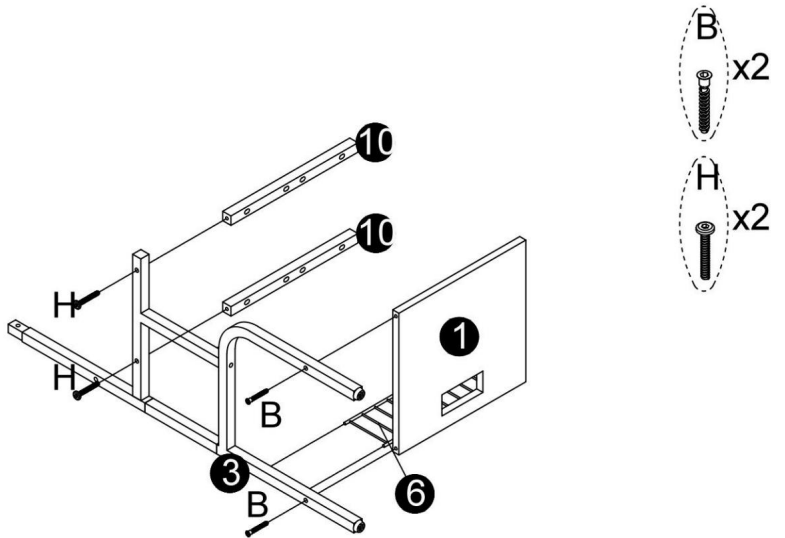

5

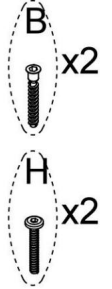
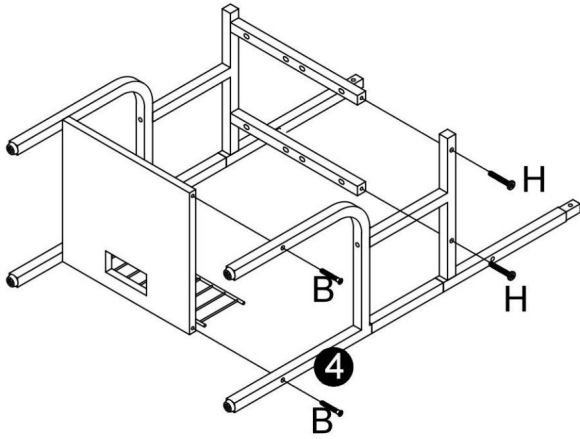

6

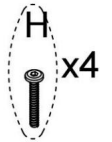
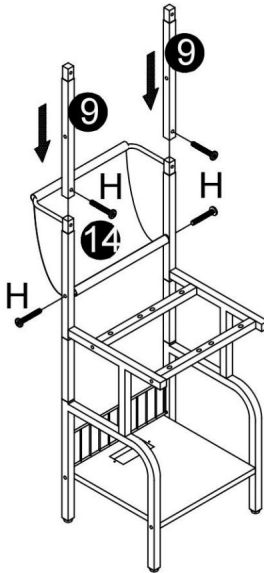

7

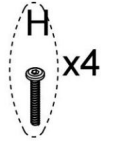
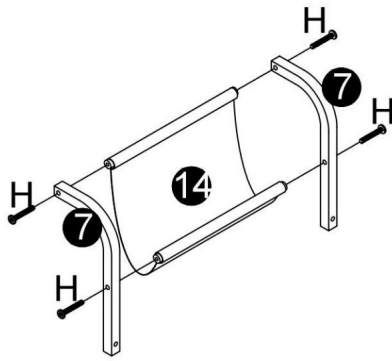

8

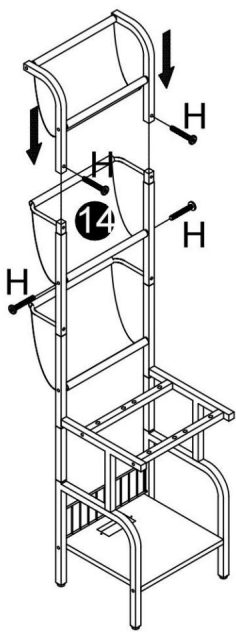

9

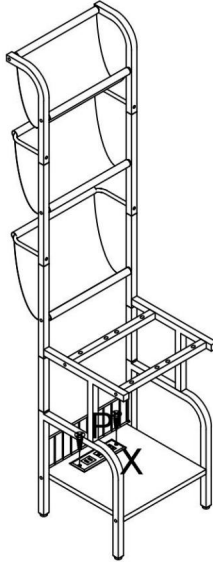

10

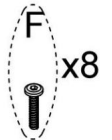
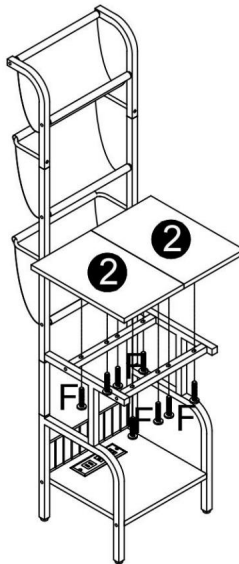

11

Z
x2



Attention: For safety and stability, we suggest you have to secure the anti-tip accessories to the wall to prevent tipping, injury, and property damage.

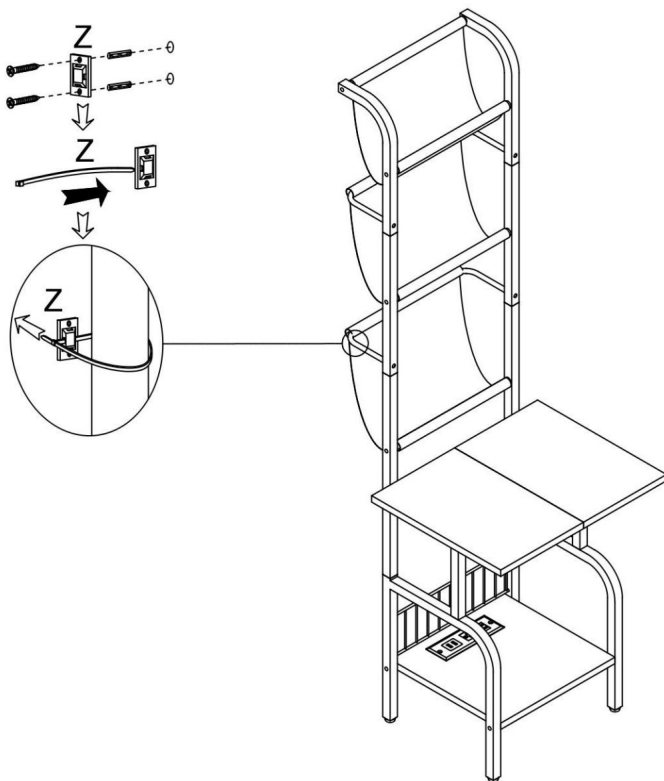

COMPLETAMENTO

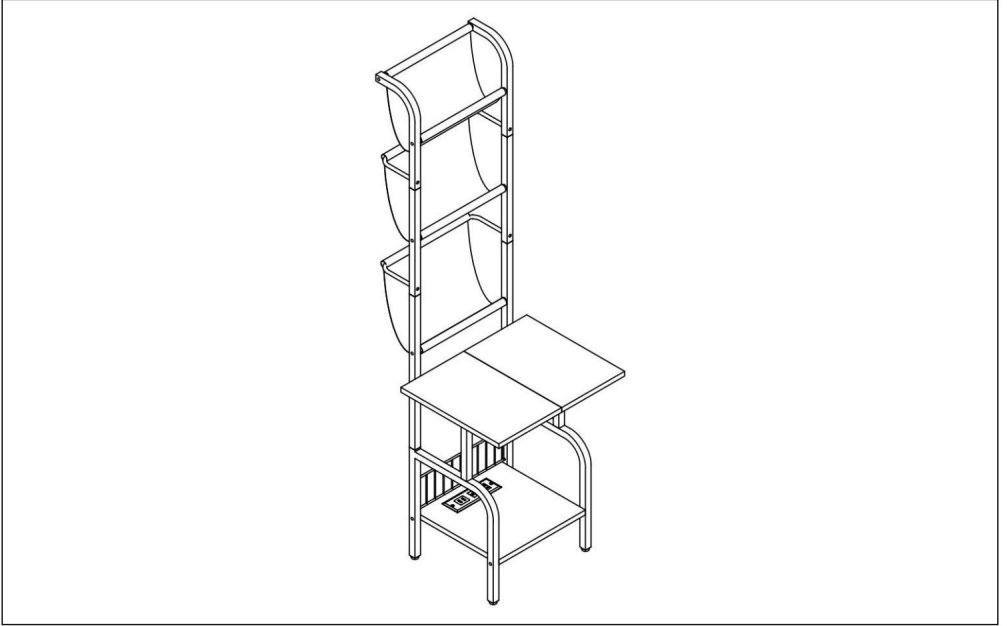

Produttore: Shanghaimuxinmuyeyouxiangongsi **Indirizzo:**

Shuangchenglu 803nong11hao1602A-1609shi, baoshanqu, shanghai 200000 CN.

Importato in AUS: SIHAO PTY LTD. 1 ROKEVA STREETEASTWOOD NSW 2122
Australia

Importato negli USA: Sanven Technology Ltd. Suite 250, 9166 Anaheim Place,
Rancho Cucamonga, CA 91730



YH CONSULTING LIMITED. C/O YH Consulting
Limited Ufficio 147, Centurion House, London
Road, Staines-upon-Thames, Surrey, TW18 4AX

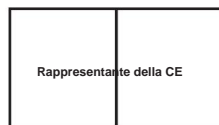

E-CrossStu GmbH
Magonza Landstr.69,
60329 Francoforte sul Meno.

VEVOR®

TOUGH TOOLS, HALF PRICE

Supporto tecnico e certificato di garanzia
elettronica www.vevor.com/support

VEVOR[®]

TOUGH TOOLS, HALF PRICE

Soporte técnico y certificado de garantía electrónica

www.vevor.com/support

SOPORTE PARA TOCADISCOS

MANUAL DEL USUARIO

N.º DE MODELO: C240354G-01

Seguimos comprometidos a brindarle herramientas a precios competitivos.

"Ahorre la mitad", "mitad de precio" o cualquier otra expresión similar que utilicemos solo representa una estimación del ahorro que podría obtener al comprar ciertas herramientas con nosotros en comparación con las principales marcas y no necesariamente significa que cubra todas las categorías de herramientas que ofrecemos. Le recordamos que, al realizar un pedido con nosotros, verifique cuidadosamente si realmente está ahorrando la mitad en comparación con las principales marcas.

VEVOR®

TOUGH TOOLS, HALF PRICE

Soporte para tocadiscos

N.º DE MODELO: C240354G-01

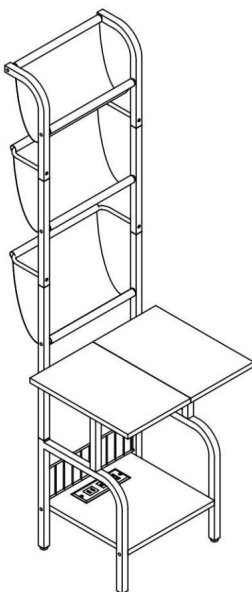

¿NECESITA AYUDA? ¡CONTÁCTENOS!

¿Tiene preguntas sobre el producto? ¿Necesita asistencia técnica? No dude en ponerse en contacto con nosotros:

Soporte técnico y certificado de garantía electrónica
www.vevor.com/support

Estas son las instrucciones originales, lea atentamente todas las instrucciones del manual antes de utilizar el producto. VEVOR se reserva una interpretación clara de nuestro manual de usuario. La apariencia del producto estará sujeta al producto que recibió. Perdónenos por no informarle nuevamente si hay actualizaciones de tecnología o software en nuestro producto.



ADVERTENCIA:

Lea atentamente este manual antes de utilizar el producto. Si no se cumple con las instrucciones, Hacerlo podría provocar lesiones graves.

PRECAUCIONES DE MONTAJE

1. Realice el montaje únicamente de acuerdo con estas instrucciones. Un montaje incorrecto puede crear peligros
2. Use gafas de seguridad aprobadas por ANSI y guantes de trabajo resistentes.
Durante el montaje.
3. Mantenga el área de reunión limpia y bien iluminada.
4. Mantenga a los transeúntes fuera del área durante el montaje.
5. No se reúna cuando esté cansado o bajo la influencia del alcohol, drogas o medicamentos.
6. Las capacidades del producto se aplican a productos ensamblados de manera correcta y completa.
Sólo productos.
7. Montar sobre una superficie plana, nivelada, dura y lisa capaz de soportar cargas de forma segura.
Soporte para el soporte del tocadiscos.
8. Para obtener información adicional sobre las piezas enumeradas a continuación, páginas, consulte el diagrama de ensamblaje de este manual. Desenvuelva y
Separar todas las piezas en un área de trabajo limpia.

GUARDE ESTAS INSTRUCCIONES

PRECAUCIONES DE USO

PARA EVITAR LESIONES GRAVES Y LA MUERTE POR VUELCO:

1. Este producto no es un juguete. No permita que los niños jueguen con él o cerca de él.
artículo.
2. No exceda las capacidades de peso antes de moverlo.
3. Utilícelo únicamente sobre una superficie plana, dura y lisa capaz de soportar cargas de forma segura.
Soporte para un soporte para tocadiscos completamente cargado.
4. Utilícelo únicamente según lo previsto.
5. Inspeccione antes de cada uso; no utilice si las piezas están sueltas o dañadas.

ESPECIFICACIONES TÉCNICAS

Modelo	C240354G-01
Calificación(es)	12 A, 125 V CA, 60 Hz, 1500 W
Dimensiones del producto (Largo x Ancho x Alto) (mm)	450*490*1430
Peso neto (kg)	Sobre las 12.35

*Productos como especificaciones, apariencia y diseño son
Sujeto a modificaciones sin previo aviso.

CONTENIDO DEL PAQUETE

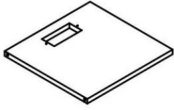

1 1pc

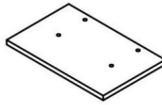

2 2pcs

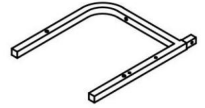

3 1pc

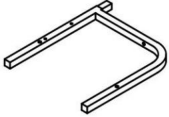

4 1pc



5 2pcs



6 1pc



7 2pcs



8 2pcs



9 2pcs



10 2pcs



11 2pcs

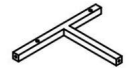







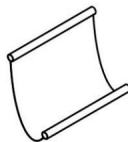









12 2pcs



13 4pcs



14 3pcs

 M7X50MM  4pcs	 M6X30MM  8pcs	 M6X40MM  20pcs	 M3.5X14MM  2pcs	 M6X10MM  2pcs	  1pc	  4pcs
 2pcs						

PASOS DE MONTAJE

1

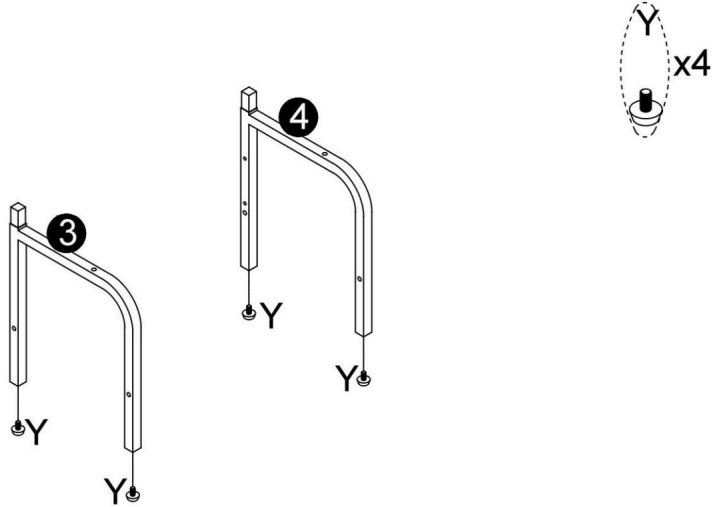

2

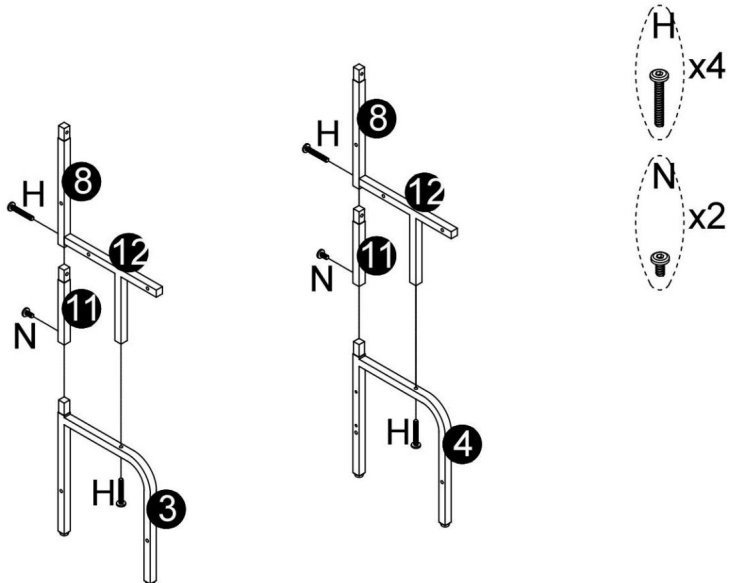

3

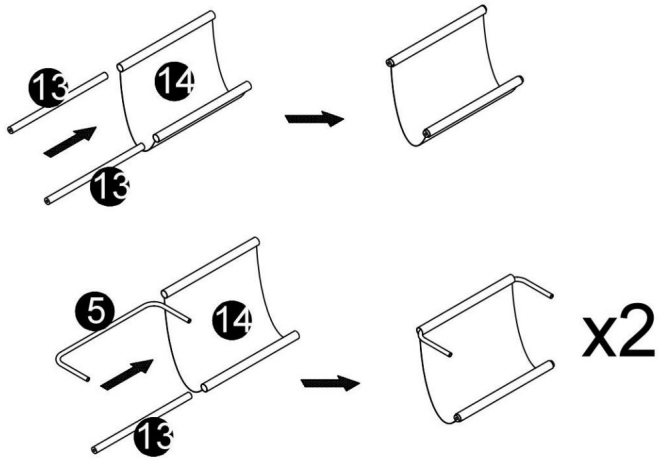

4

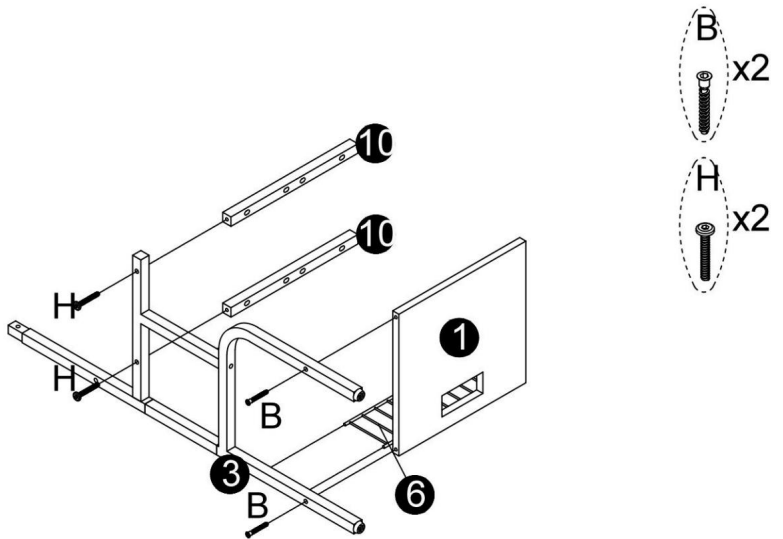

5

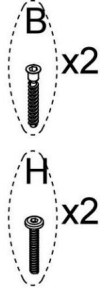
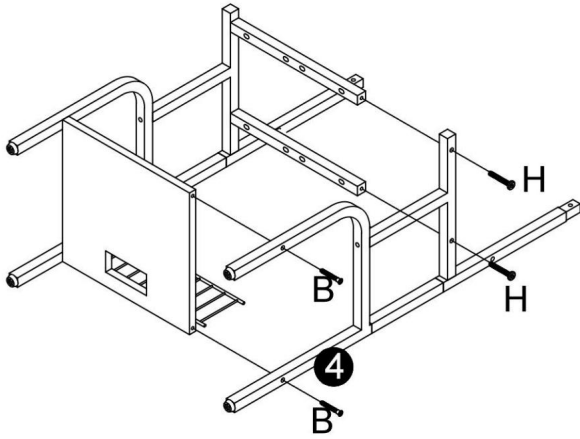

6

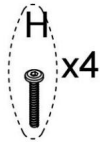
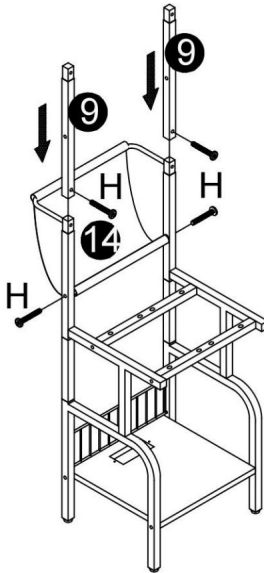

7

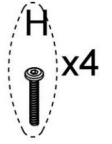
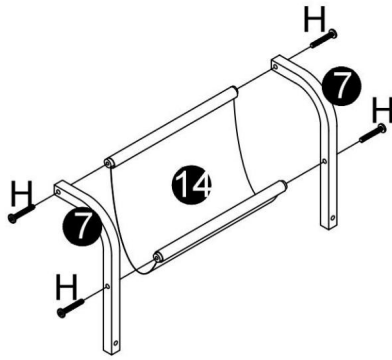

8

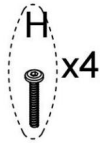
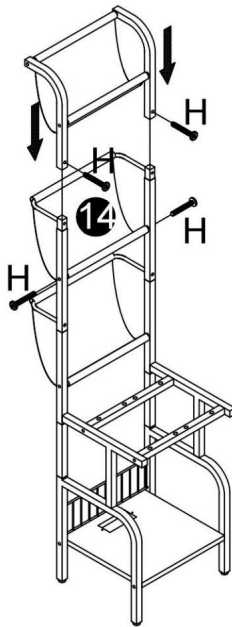

9

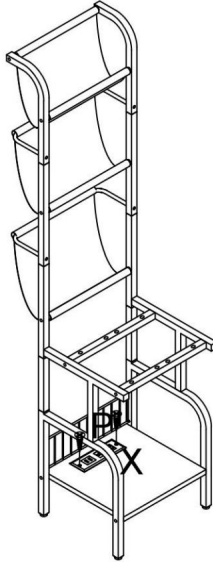

10

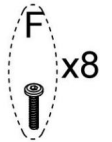
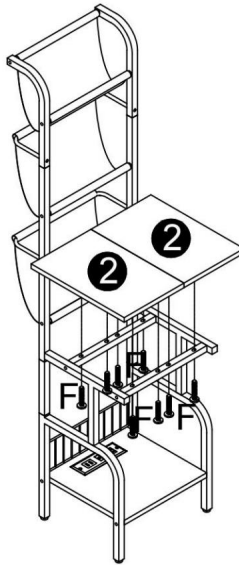

11

Z
x2



Attention: For safety and stability, we suggest you have to secure the anti-tip accessories to the wall to prevent tipping, injury, and property damage.

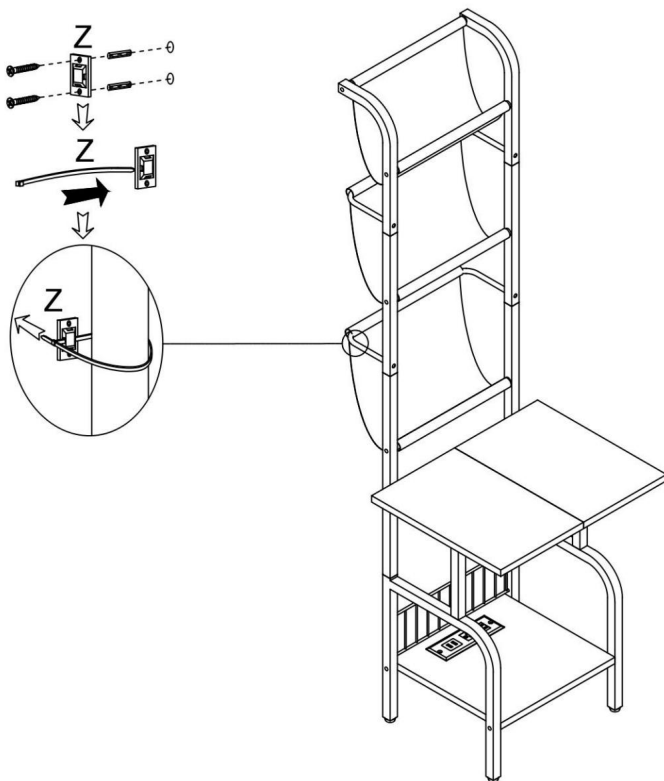

TERMINACIÓN

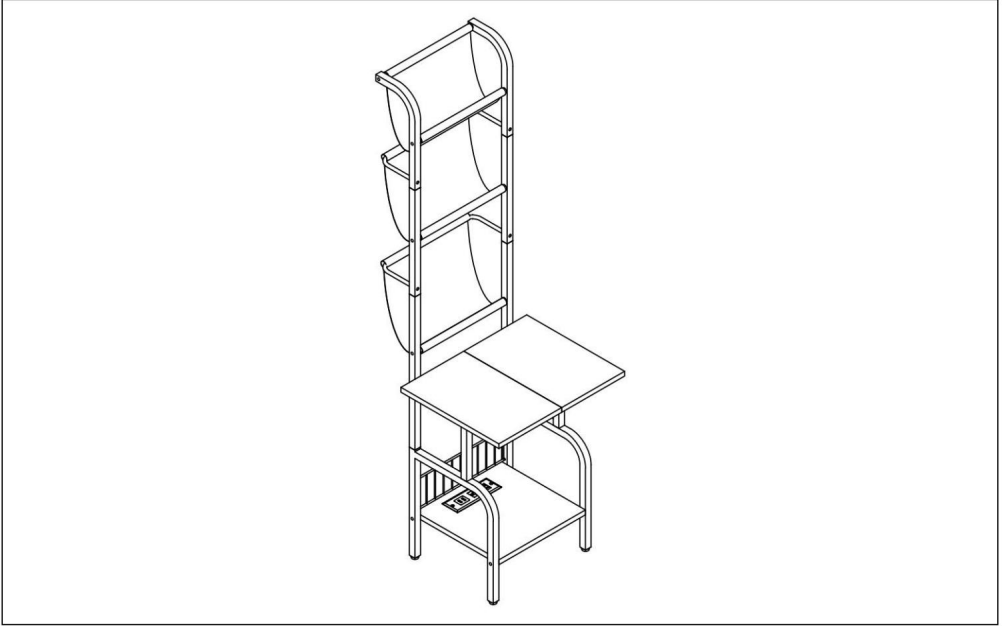

Fabricante: Shanghaimuxinmuyeyouxiangongsi Dirección:
Shuangchenglu 803nong11hao1602A-1609shi, baoshanqu, shanghai 200000 CN.

Importado a AUS: SIHAO PTY LTD. 1 ROKEVA STREETEASTWOOD NSW 2122
Australia

Importado a EE. UU.: Sanven Technology Ltd. Suite 250, 9166 Anaheim Place,
Rancho Cucamonga, CA 91730

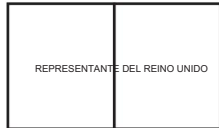

YH CONSULTING LIMITED. A LA DIRECCIÓN DE YH
Consulting Limited Oficina 147, Centurion House, London
Road, Staines-upon-Thames, Surrey, TW18 4AX

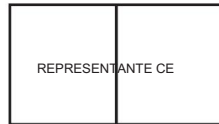

E-CrossStu GmbH
Mainzer Landstraße 69,
60329 Fráncfort del Meno.

VEVOR[®]

TOUGH TOOLS, HALF PRICE

Soporte técnico y certificado de garantía
electrónica www.vevor.com/support

VEVOR®

TOUGH TOOLS, HALF PRICE

Wsparcie techniczne i certyfikat gwarancji

elektronicznej www.vevor.com/support

STOJAK NA GRAMPERY

INSTRUKCJA OBSŁUGI

NR MODELU: C240354G-01

Nadal staramy się oferować Państwu narzędzia w konkurencyjnych cenach. „Oszczędzaj połowę”, „Połowa ceny” lub inne podobne wyrażenia używane przez nas stanowią jedynie szacunkowe oszczędności, jakie możesz uzyskać, kupując u nas określone narzędzia w porównaniu z głównymi markami i niekoniecznie oznaczają one objęcie wszystkich kategorii oferowanych przez nas narzędzi. Uprzejmie przypominamy, aby przy składaniu zamówienia dokładnie sprawdzić, czy faktycznie oszczędzasz połowę w porównaniu z głównymi markami.

VEVOR[®]

TOUGH TOOLS, HALF PRICE

Stojak na gramofon

NR MODELU: C240354G-01

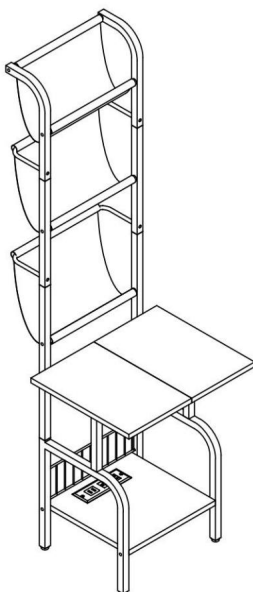

POTRZEBUJESZ POMOCY? SKONTAKTUJ SIĘ Z NAMI!

Masz pytania dotyczące produktu? Potrzebujesz wsparcia technicznego? Skontaktuj się z nami:

Wsparcie techniczne i certyfikat gwarancji
elektronicznej www.vevor.com/support

To jest oryginalna instrukcja, przed użyciem należy uważnie przeczytać wszystkie instrukcje. VEVOR zastrzega sobie jasną interpretację naszej instrukcji obsługi. Wygląd produktu będzie zależał od produktu, który otrzymałeś. Prosimy o wybaczenie, że nie poinformujemy Cię ponownie, jeśli w naszym produkcie pojawią się jakiegokolwiek aktualizacje technologiczne lub oprogramowania.



OSTRZEŻENIE:

Przed użyciem produktu należy uważnie przeczytać tę instrukcję. Nieprzestrzeganie niestosowanie się do tego zalecenia może skutkować poważnymi obrażeniami.

ŚRODKI OSTROŻNOŚCI PODCZAS MONTAŻU

1. Montaż należy wykonywać wyłącznie zgodnie z niniejszą instrukcją. Nieprawidłowy montaż może stwarzać zagrożenia.
2. Noś okulary ochronne zatwierdzone przez ANSI i wytrzymałe rękawice robocze. w trakcie montażu.
3. Utrzymuj miejsce zgromadzenia w czystości i zapewnij dobre oświetlenie.
4. Podczas montażu nie dopuszczaj osób postronnych na teren montażu.
5. Nie przychodź na spotkania, jeśli jesteś zmęczony lub pod wpływem alkoholu, narkotyków lub leków.
6. Możliwości produktu dotyczą prawidłowego i kompletnego montażu tylko produkty.
7. Montaż należy wykonać na płaskiej, równej, twardej i gładkiej powierzchni, która będzie bezpieczna. podtrzymujący stojak na gramofon.
8. Aby uzyskać dodatkowe informacje dotyczące części wymienionych poniżej, strony, zapoznaj się ze schematem montażu w tym podręczniku. Rozpakuj i oddzielić wszystkie części w czystym miejscu pracy.

ZAPISZ TE INSTRUKCJE

ŚRODKI OSTROŻNOŚCI

ABY ZAPOBIEC POWAŻNYM OBRAŻENIOM I ŚMIERCI SPOWODOWANEJ PRZEWRÓCENIEM:

1. Ten produkt nie jest zabawką. Nie pozwalaj dzieciom bawić się nim ani przebywać w jego pobliżu.

przedmiot.

2. Nie przekraczaj dopuszczalnego ciężaru przed przeprowadzką.

3. Używać wyłącznie na płaskiej, twardej i gładkiej powierzchni, która umożliwia bezpieczne użytkowanie.

podtrzymuje w pełni wyposażony stojak na gramofon.

4. Używać wyłącznie zgodnie z przeznaczeniem.

5. Przed każdym użyciem należy przeprowadzić kontrolę. Nie należy używać produktu, jeśli jakieś części są luźne lub uszkodzone.

DANE TECHNICZNE

Model	C240354G-01
Ocena(y)	12 A, 125 V prądu przemiennego, 60 Hz, 1500 W
Wymiary produktu (Dł. x Szer. x Wys.) (mm)	450*490*1430
Masa netto (kg)	Około 12.35

***Produkty takie jak specyfikacje, wygląd i projekt są**

Zastrzega się możliwość zmian bez wcześniejszego powiadomienia.

ZAWARTOŚĆ OPAKOWANIA

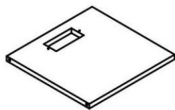

1 1pc

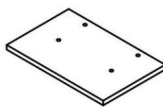

2 2pcs

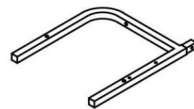

3 1pc

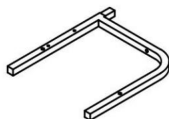

4 1pc



5 2pcs



6 1pc



7 2pcs



8 2pcs



9 2pcs



10 2pcs



11 2pcs

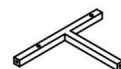







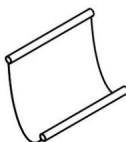









12 2pcs



13 4pcs



14 3pcs

 M7X50MM  4pcs	 M6X30MM  8pcs	 M6X40MM  20pcs	 M3.5X14MM  2pcs	 M6X10MM  2pcs	  1pc	  4pcs
 2pcs						

KROKI MONTAŽU

1

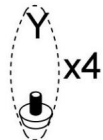
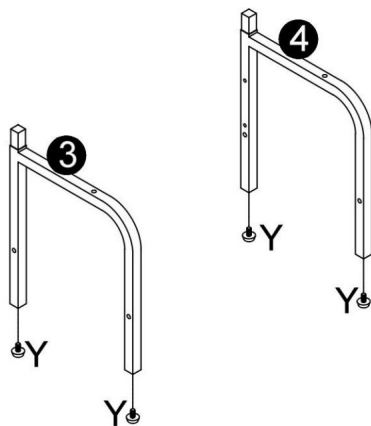

2

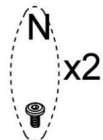
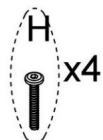
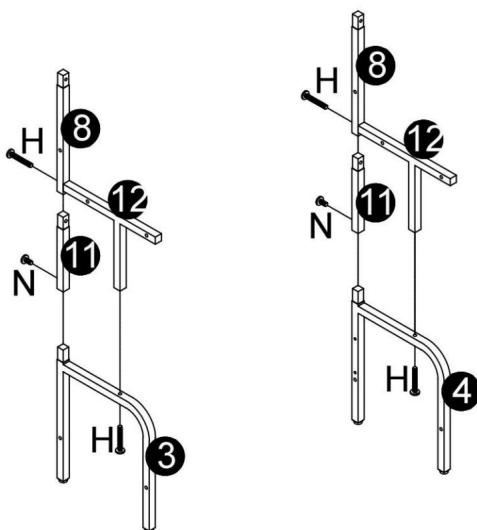

3

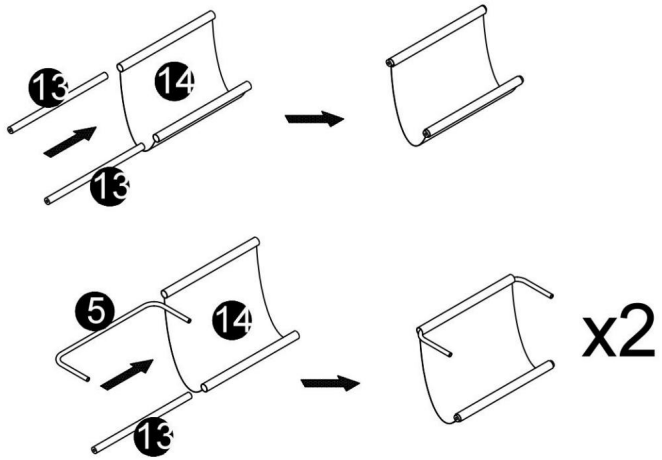

4

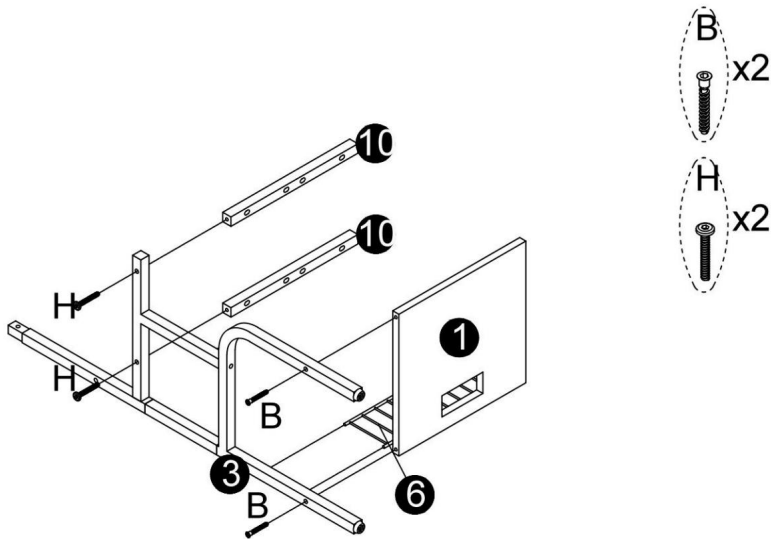

5

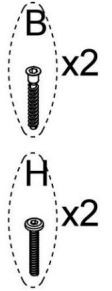
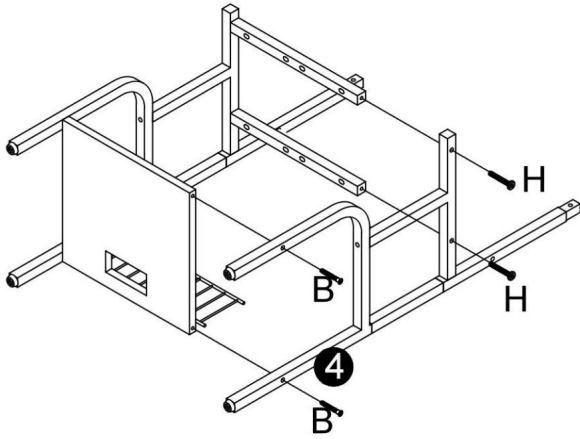

6

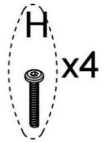
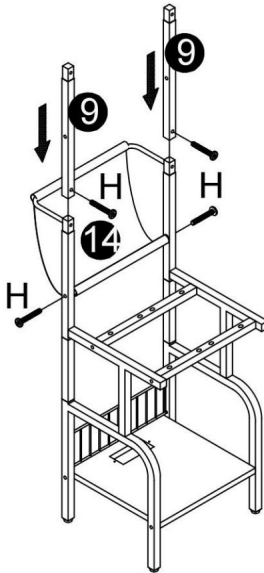

7

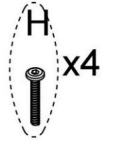
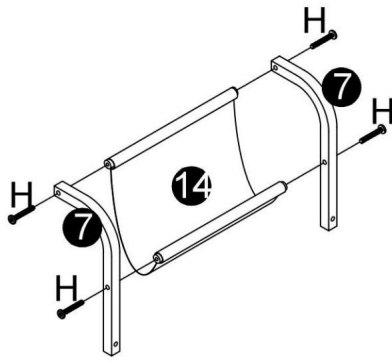

8

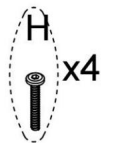
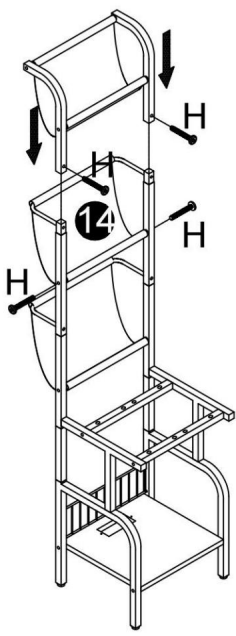

9

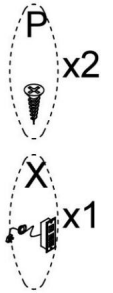
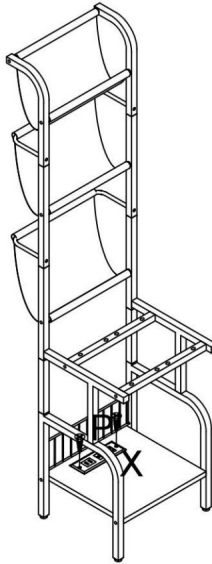

10

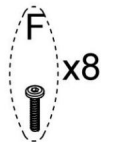
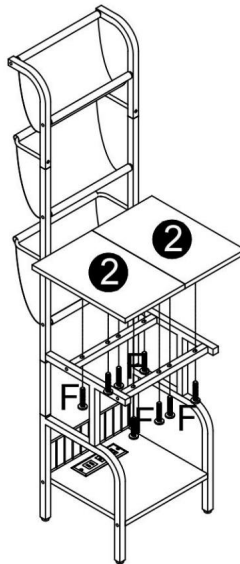

11

Z
x2



Attention: For safety and stability, we suggest you have to secure the anti-tip accessories to the wall to prevent tipping, injury, and property damage.

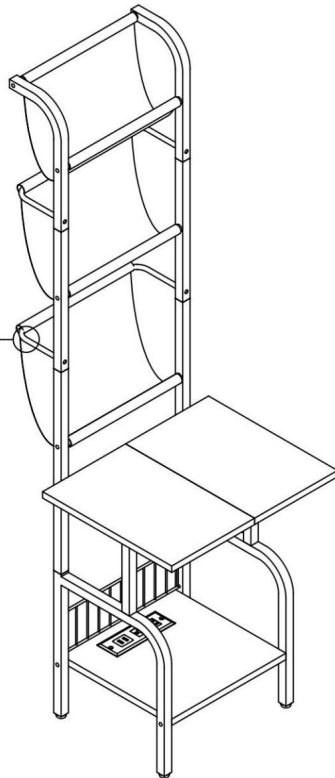
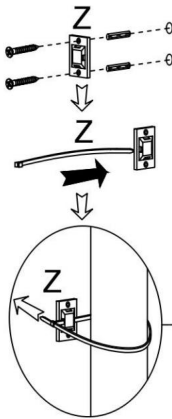

UKOŃCZENIE

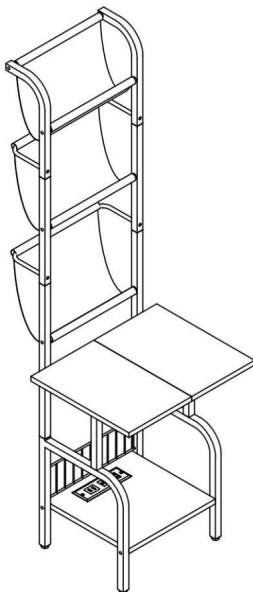

Producent: Shanghaimuxinmuyeyouxiangongsi Adres:

Shuangchenglu 803nong11hao1602A-1609shi, baoshanqu, szanghaj 200000 CN.

Importowane do AUS: SIHAO PTY LTD. 1 ROKEVA STREETEASTWOOD NSW 2122 Australia

Importowane do USA: Sanven Technology Ltd. Suite 250, 9166 Anaheim Place, Rancho Cucamonga, CA 91730



YH CONSULTING LIMITED. C/O YH Consulting Limited
Biuro 147, Centurion House, London Road, Staines-
upon-Thames, Surrey, TW18 4AX



E-CrossStu GmbH
Mainzer Landstr.69,
60329 Frankfurt nad Menem.

VEVOR®

TOUGH TOOLS, HALF PRICE

Wsparcie techniczne i certyfikat gwarancji
elektronicznej www.vevor.com/support

VEVOR[®]

TOUGH TOOLS, HALF PRICE

Technische ondersteuning en e-garantiecertificaat

www.vevor.com/support

PLATENSPEL STANDAARD REK

GEBRUIKERSHANDLEIDING

MODELNUMMER: C240354G-01

Wij streven er voortdurend naar om u gereedschappen tegen concurrerende prijzen te leveren. "Save Half", "Half Price" of andere soortgelijke uitdrukkingen die wij gebruiken, geven alleen een schatting weer van de besparingen die u kunt behalen door bepaalde gereedschappen bij ons te kopen in vergelijking met de grote topmerken en betekent niet noodzakelijkerwijs dat alle categorieën gereedschappen die wij aanbieden, worden gedekt. Wij herinneren u eraan om zorgvuldig te controleren of u daadwerkelijk de helft bespaart in vergelijking met de grote topmerken wanneer u een bestelling bij ons plaatst.

VEVOR[®]

TOUGH TOOLS, HALF PRICE

Platenspeler standaard rek

MODELNUMMER: C240354G-01

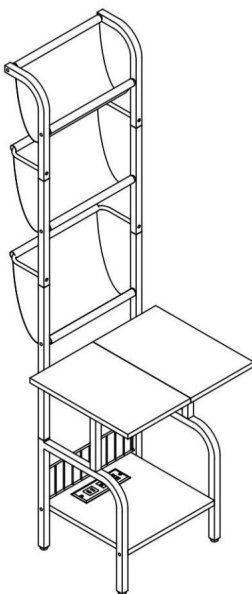

HULP NODIG? NEEM CONTACT MET ONS OP!

Heeft u vragen over het product? Heeft u technische ondersteuning nodig? Neem dan gerust contact met ons op:

Technische ondersteuning en e-garantiecertificaat
www.vevor.com/support

Dit is de originele instructie, lees alle handleidingen zorgvuldig door voordat u het product gebruikt. VEVOR behoudt zich een duidelijke interpretatie van onze gebruikershandleiding voor. Het uiterlijk van het product is afhankelijk van het product dat u hebt ontvangen. Vergeef ons dat we u niet opnieuw zullen informeren als er technologie- of software-updates voor ons product zijn.



WAARSCHUWING:

Lees deze handleiding zorgvuldig door voordat u het product gebruikt. Als u dit niet doet, Als u dit toch doet, kan dit ernstig letsel tot gevolg hebben.

MONTAGEVOORZORGSMATREGELEN

1. Monteer alleen volgens deze instructies. Onjuiste montage kan gevaren creëren.
2. Draag een door ANSI goedgekeurde veiligheidsbril en stevige werkhandschoenen tijdens de montage.
3. Zorg ervoor dat de verzamelplaats schoon en goed verlicht is.
4. Houd omstanders uit de buurt tijdens de montage.
5. Kom niet bijeen als u moe bent of onder invloed van alcohol, drugs of medicijnen.
6. De producteigenschappen gelden voor correct en volledig gemonteerde producten. alleen producten.
7. Monteer op een vlak, egaal, hard en glad oppervlak dat veilig kan worden gebruikt ter ondersteuning van het platenspelerstandaardrek.
8. Voor aanvullende informatie over de onderdelen die in de volgende lijst staan vermeld, pagina's, raadpleeg dan het montageschema van deze handleiding. Uitpakken en Scheid alle onderdelen in een schone werkruimte.

BEWAAR DEZE INSTRUCTIES

GEBRUIK VOORZORGSMAATREGELEN

OM ERNSTIG LETSEL EN DE DOOD DOOR KANTELEN TE VOORKOMEN:

1. Dit product is geen speelgoed. Laat kinderen niet met of in de buurt van dit product spelen.
item.
2. Overschrijd het toegestane gewicht niet voordat u het verplaatst.
3. Gebruik het alleen op een vlak, hard en glad oppervlak dat veilig kan worden gebruikt.
ter ondersteuning van een volledig geladen platenspelerstandaard.
4. Gebruik het product alleen zoals bedoeld.
5. Controleer het apparaat voor elk gebruik. Gebruik het apparaat niet als er onderdelen loszitten of beschadigd zijn.

TECHNISCHE SPECIFICATIES

Model	C240354G-01
Beoordeling(en)	12A, 125Vac, 60Hz, 1500W
Productafmetingen (LxBxH)(mm)	450*490*1430
Nettogewicht (kg)	Ongeveer 12.35

*Producten zoals specificaties, uiterlijk en ontwerp zijn

Onder voorbehoud van wijzigingen zonder voorafgaande kennisgeving.

INHOUD VAN HET PAKKET

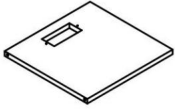

1 1pc

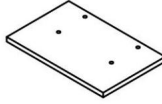

2 2pcs

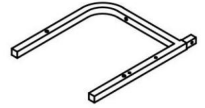

3 1pc

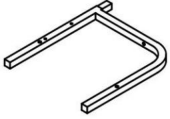

4 1pc



5 2pcs



6 1pc



7 2pcs



8 2pcs



9 2pcs



10 2pcs



11 2pcs

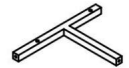







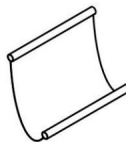

12 2pcs



13 4pcs



14 3pcs

 M7X50MM B 4pcs	 M6X30MM F 8pcs	 M6X40MM H 20pcs	 M3.5X14MM P 2pcs	 M6X10MM N 2pcs	 X 1pc	 Y 4pcs
 Z 2pcs						

MONTAGESTAPPEN

1

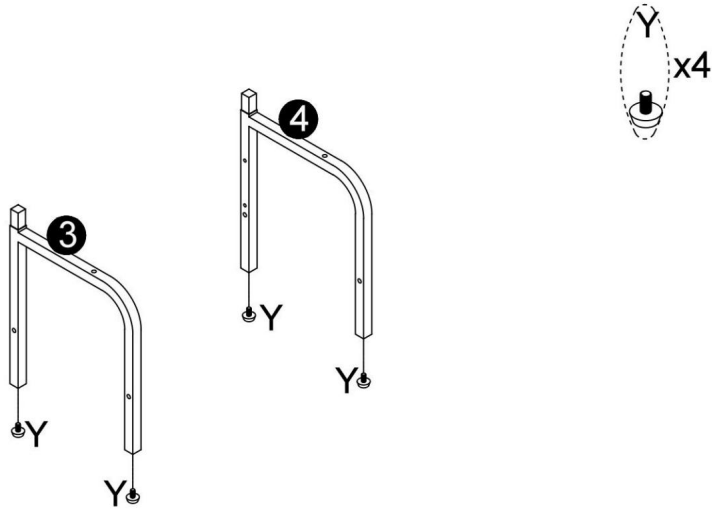

2

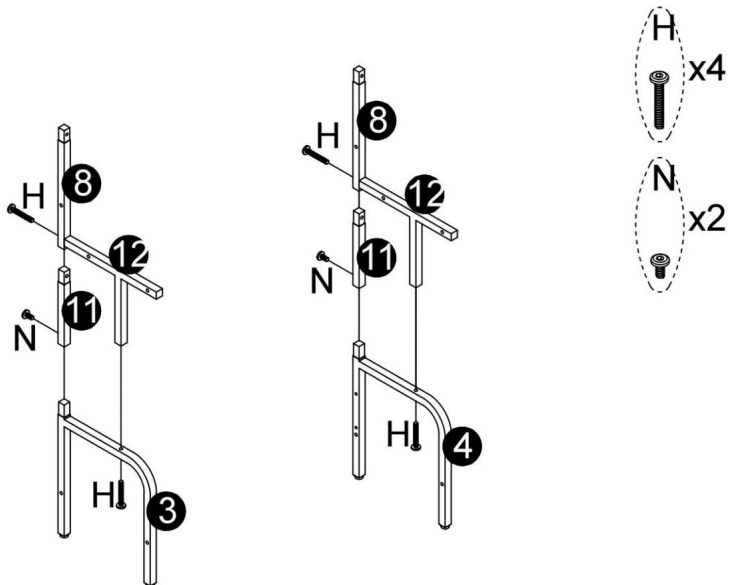

3

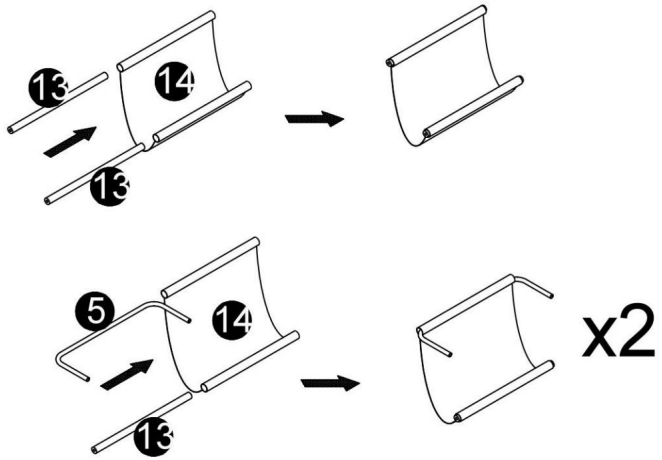

4

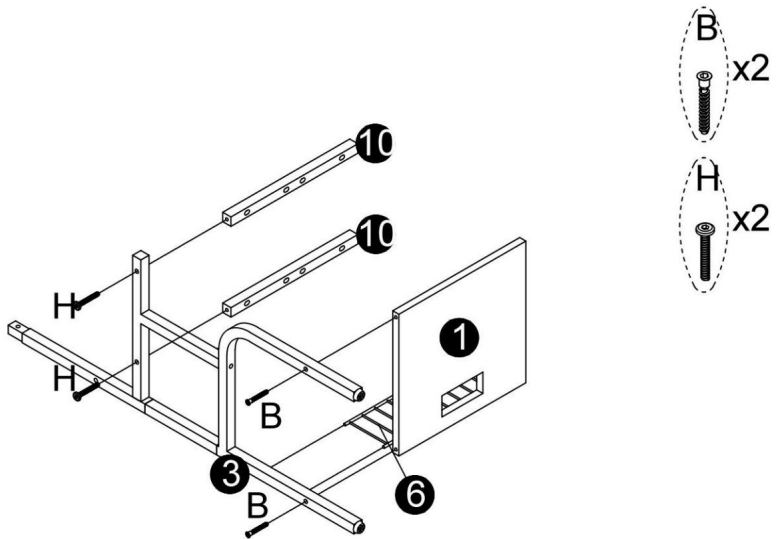

5

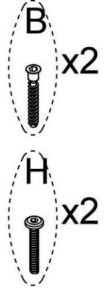
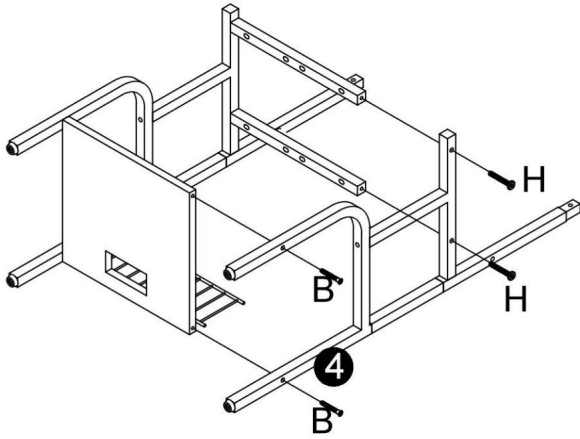

6

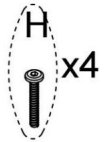
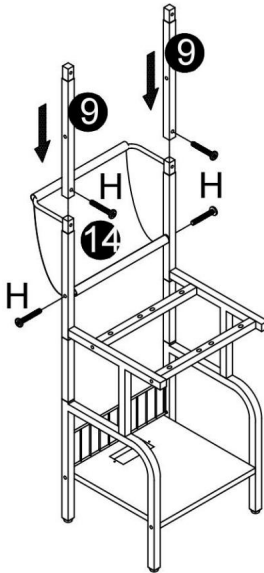

7

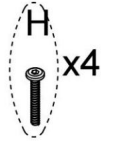
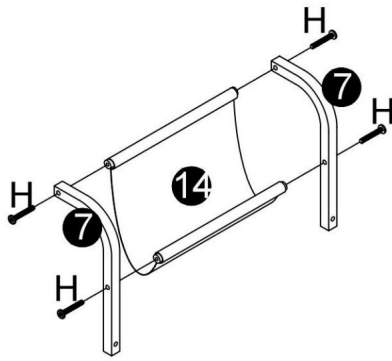

8

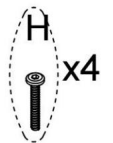
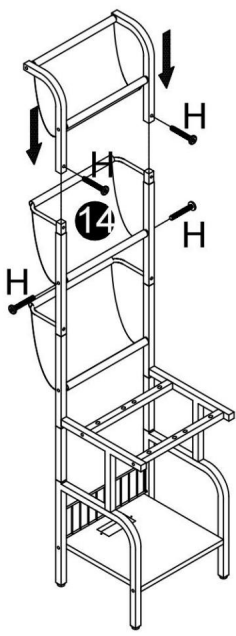

9

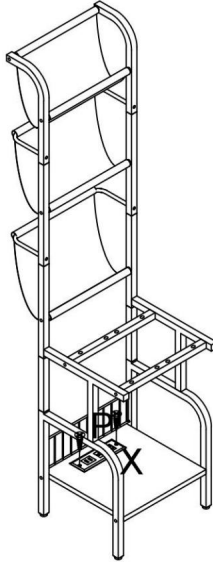

10

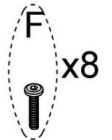
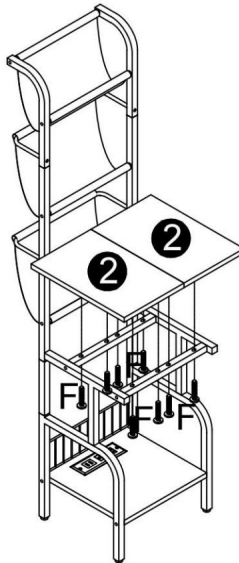

11

Z
x2

 Attention: For safety and stability, we suggest you have to secure the anti-tip accessories to the wall to prevent tipping, injury, and property damage.

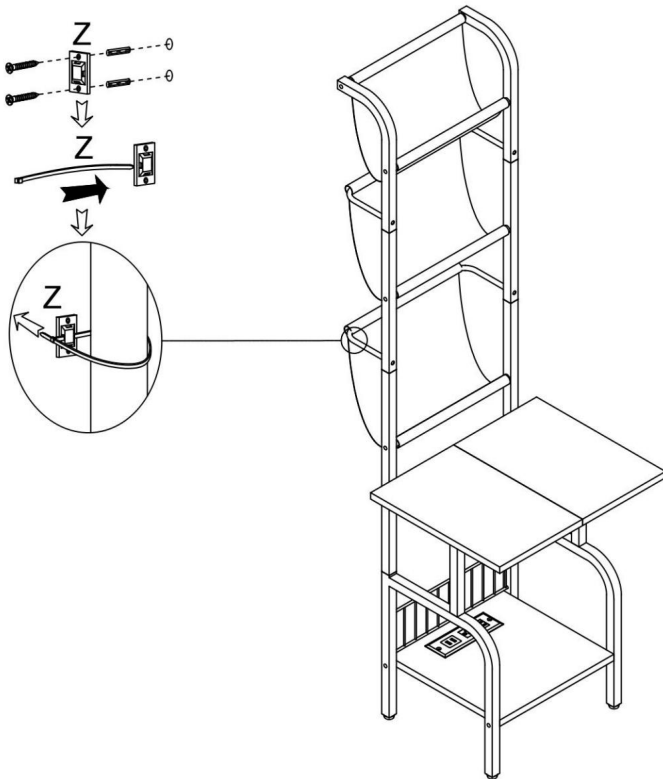

VOLTOOIING

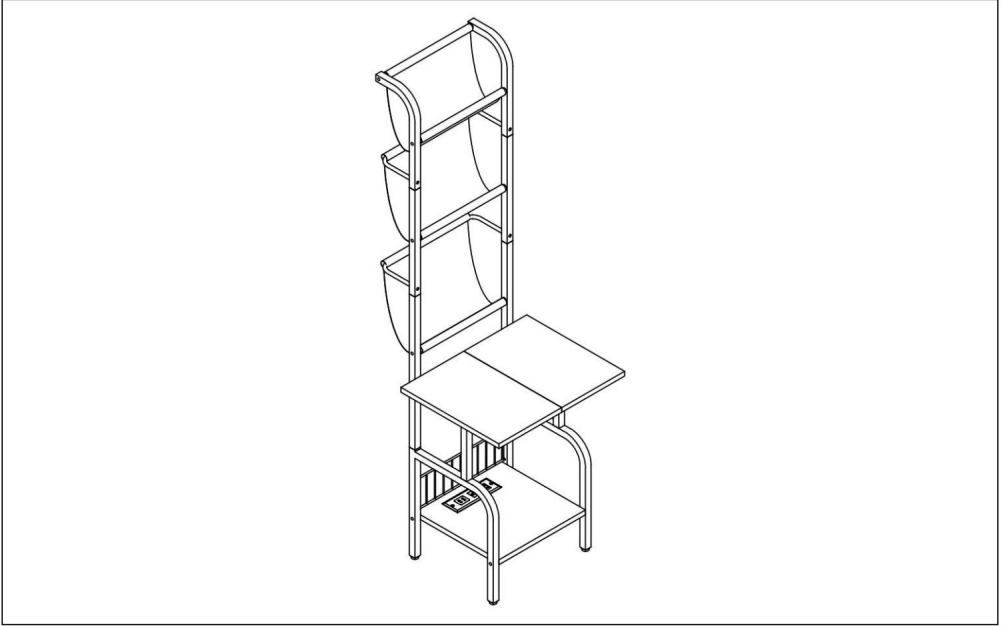

Fabrikant: Shanghaimuxinmuyeyouxiangongsi **Adres:**

Shuangchenglu 803nong11hao1602A-1609shi, baoshanqu, shanghai 200000 CN.

Geïmporteerd naar AUS: SIHAO PTY LTD. 1 ROKEVA STREETEASTWOOD NSW
2122 Australië

Geïmporteerd naar de VS: Sanven Technology Ltd. Suite 250, 9166 Anaheim Place,
Rancho Cucamonga, CA 91730



YH CONSULTING LIMITED. C/O YH Consulting
Limited Kantoor 147, Centurion House, London
Road, Staines-upon-Thames, Surrey, TW18 4AX



E-CrossStu GmbH
Mainzer Landstr.69,
60329 Frankfort aan de Main.

VEVOR[®]

TOUGH TOOLS, HALF PRICE

**Technische ondersteuning en e-
garantiecertificaat www.vevor.com/support**

VEVOR[®]

TOUGH TOOLS, HALF PRICE

Teknisk support och e-garanticertifikat
www.vevor.com/support

SKIVSTÄLLARE

ANVÄNDARMANUAL

MODELLNR: C240354G-01

Vi fortsätter att vara engagerade i att ge dig verktyg till konkurrenskraftiga priser. "Spara hälften", "halva priset" eller andra liknande uttryck som används av oss representerar bara en uppskattning av besparingar du kan dra nytta av att köpa vissa verktyg hos oss jämfört med de stora toppmärkena och betyder inte nödvändigtvis att täcka alla kategorier av verktyg som erbjuds av oss. Du påminns om att noggrant kontrollera när du gör en beställning hos oss om du verkligen sparar hälften i jämförelse med de främsta varumärkena.

VEVOR®

TOUGH TOOLS, HALF PRICE

Stativ för skivspelare

MODELLNR: C240354G-01

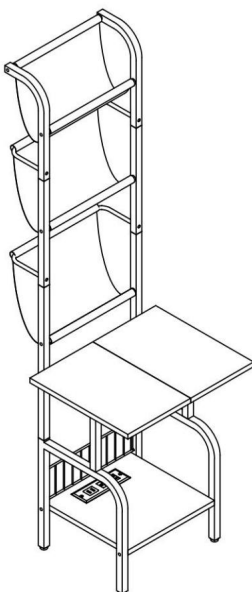

BEHÖVER HJÄLP? KONTAKTA OSS!

Har du produktfrågor? Behöver du teknisk support? Kontakta oss gärna:

Teknisk support och e-garanticertifikat
www.vevor.com/support

Detta är den ursprungliga instruktionen, läs alla instruktioner noggrant innan du använder den. VEVOR reserverar sig för en tydlig tolkning av vår användarmanual. Utseendet på produkten är beroende av den produkt du fått. Ursäkta oss att vi inte kommer att informera dig igen om det finns någon teknik eller mjukvaruuppdateringar på vår produkt.



Läs denna bruksanvisning noggrant innan du använder produkten. Underlåtenhet att om du gör det kan det leda till allvarliga skador.

FÖRSIKTIGHETSÅTGÄRDER FÖR MONTERING

1. Montera endast enligt dessa instruktioner. Felaktig montering kan skapa faror.
2. Bär ANSI-godkända skyddsglasögon och kraftiga arbetshandskar under monteringen.
3. Håll monteringsområdet rent och väl upplyst.
4. Håll åskådare borta från området under monteringen.
5. Sätt dig inte ihop när du är trött eller påverkad av alkohol, droger eller mediciner.
6. Produktens egenskaper gäller för korrekt och fullständigt monterade endast produkter.
7. Montera på en plan, jämn, hård och slät yta som kan säkert stöder skivspelarens stativ.
8. För ytterligare information om delarna som anges nedan sidorna, se monteringsdiagrammet i denna manual. Packa upp och separera alla delar i ett rent arbetsområde.

SPARA DESSA INSTRUKTIONER

ANVÄND FÖRSIKTIGHETSÅTGÄRDER

FÖR ATT FÖRHINDRA ALLVARLIGA SKADA OCH DÖDSFALL VID VÄLLNING:

1. Denna produkt är inte en leksak. Låt inte barn leka med eller i närheten av detta punkt.
2. Överskrid inte viktkapaciteten innan du flyttar.
3. Använd endast på en plan, hård och slät yta som är säker som stöder ett fullt laddat stativ för skivspelare.
4. Använd endast på avsett sätt.
5. Inspektera före varje användning; Använd inte om delar är lösa eller skadade.

TEKNISKA SPECIFIKATIONER

Modell	C240354G-01
Betyg(er)	12A, 125Vac, 60Hz, 1500W
Produktens mått (LxBxH)(mm)	450*490*1430
Nettovikt (kg)	Cirka 12.35

*Produkter som specifikationer, utseende och design är kan ändras utan föregående meddelande.

FÖRPACKNINGENS INNEHÅLL

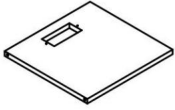

1 1pc

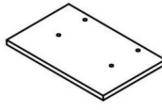

2 2pcs

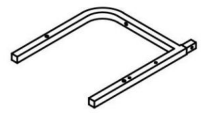

3 1pc

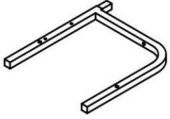

4 1pc



5 2pcs



6 1pc



7 2pcs



8 2pcs



9 2pcs



10 2pcs



11 2pcs

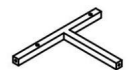







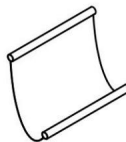











12 2pcs



13 4pcs



14 3pcs

 M7X50MM  4pcs	 M6X30MM  8pcs	 M6X40MM  20pcs	 M3.5X14MM  2pcs	 M6X10MM  2pcs	  1pc	  4pcs
  2pcs	 					

MONTERINGSSEG

1

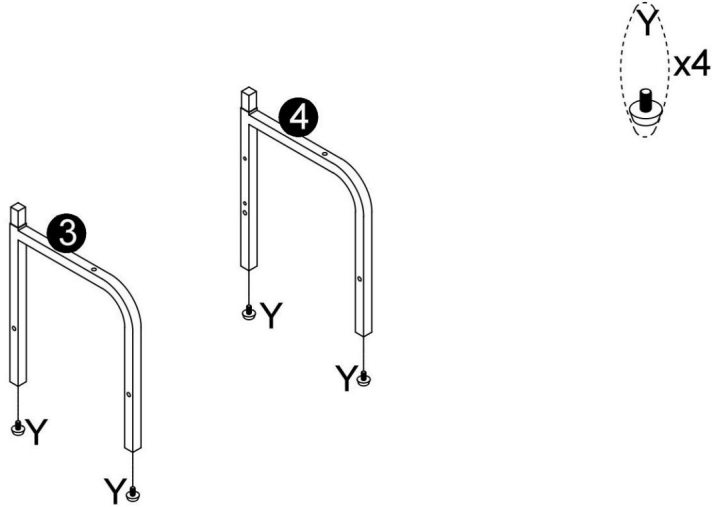

2

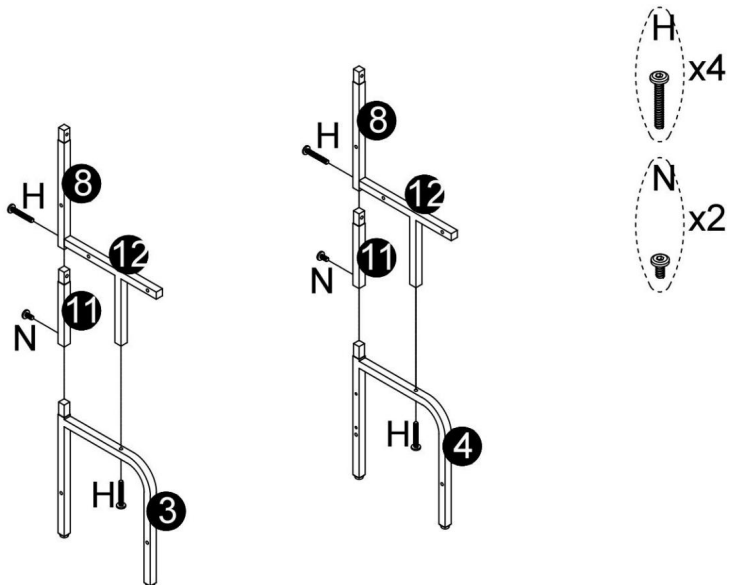

5

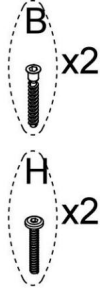
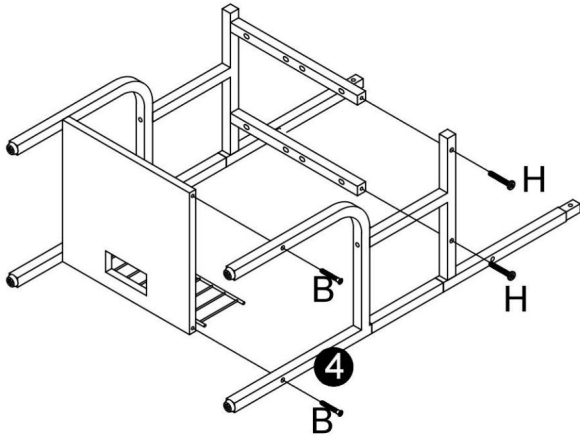

6

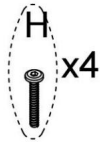
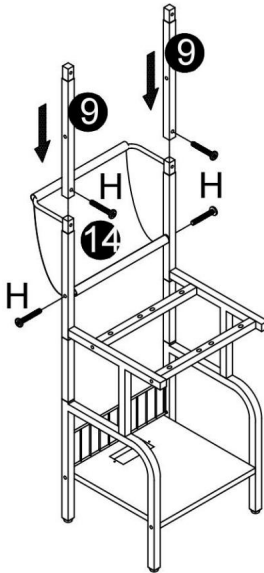

7

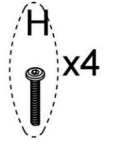
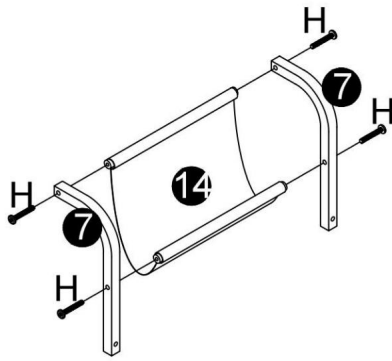

8

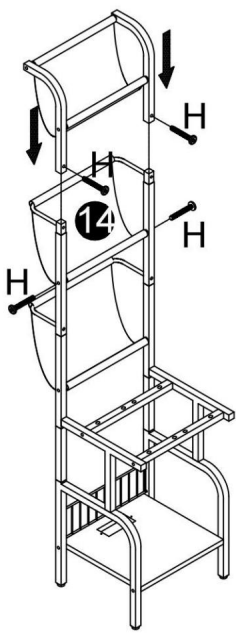

9

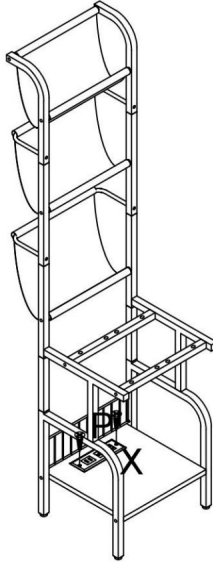

10

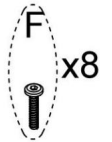
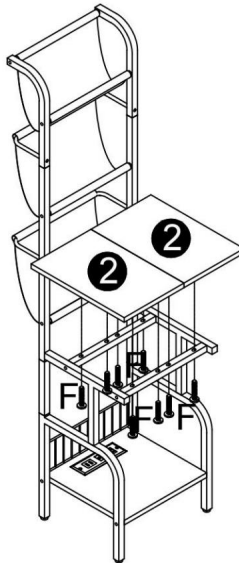

11

Z
x2



Attention: For safety and stability, we suggest you have to secure the anti-tip accessories to the wall to prevent tipping, injury, and property damage.

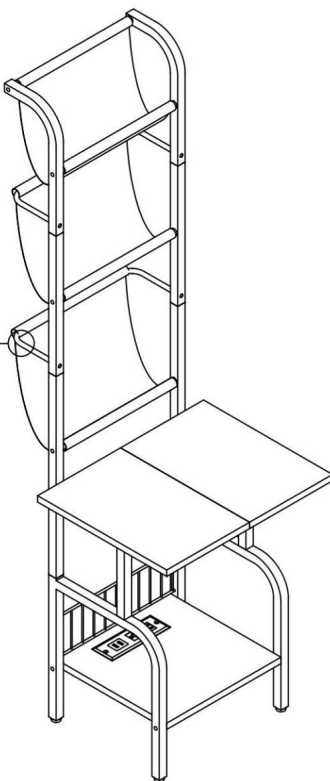
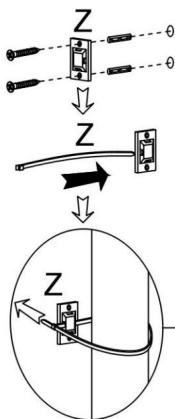

KOMPLETTERING

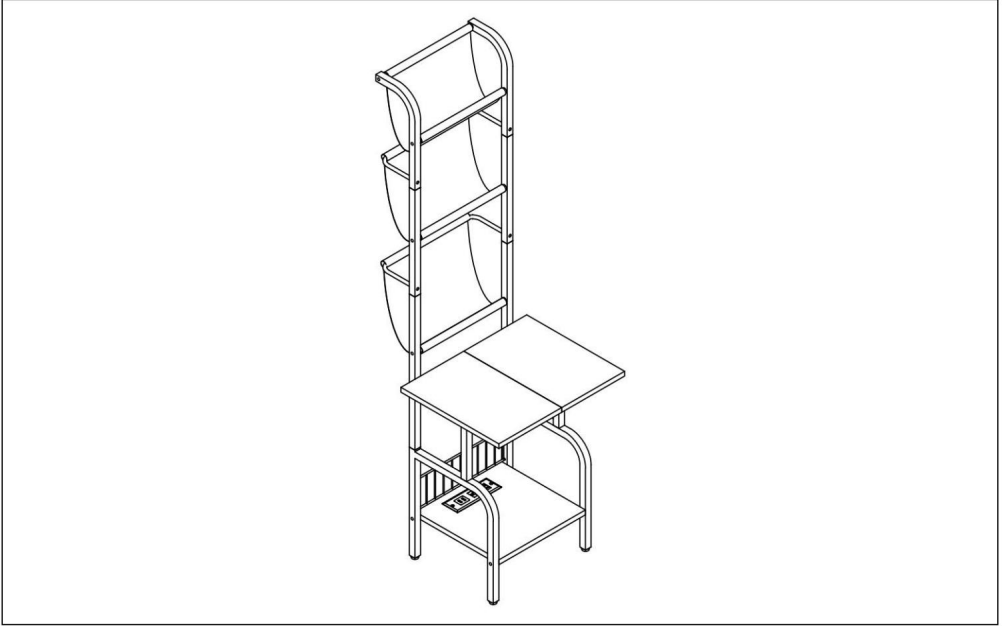

Tillverkare: Shanghaimuxinmuyeyouxiangongsi **Adress:**

Shuangchenglu 803nong11hao1602A-1609shi, baoshanqu, shanghai 200000 CN.

Importerad till AUS: SIHAO PTY LTD. 1 ROKEVA STREETEASTWOOD NSW 2122

Australien

Importerad till USA: Sanven Technology Ltd. Suite 250, 9166 Anaheim Place,

Rancho Cucamonga, CA 91730



YH CONSULTING LIMITED. C/O YH Consulting

Limited Office 147, Centurion House, London

Road, Staines-upon-Thames, Surrey, TW18 4AX



E-CrossStu GmbH

Mainzer Landstr.69,

60329 Frankfurt am Main.

VEVOR®

TOUGH TOOLS, HALF PRICE

Teknisk support och e-garanticertifikat

www.vevor.com/support